

**Technical Solutions  
from the leader of  
Pulse Tool  
Technology**

  
**COOPER** Tools

***Message from the President of CooperTools:***

*“CooperTools is proud to present this technical publication to our friends and customers. We are committed to creating value for our customers and to share with them the rewards of our engineering and manufacturing initiatives.*

*Therefore, it would give me special pleasure to see the readers inspired with the opportunity to unlock added productivity gains that pulse tool technology offers.”*

***A. Peter Held***

## History of Cooper Industries and CooperTools

From its origins in 1833 as a small iron foundry in Mount Vernon, Ohio, Cooper Industries has evolved into a diversified, multi-billion dollar manufacturing company with a worldwide presence. Headquartered in Houston, Texas, the company employs approximately 30,000 people and operates more than 100 manufacturing facilities worldwide.

Cooper Industries manufactures thousands of quality products that are grouped into two business segments: Electrical Products and Tools & Hardware.

Headquartered in Lexington, SC, the Tools & Hardware segment known as **CooperTools** serves primarily the global automotive, aerospace, electronic, energy, general industry and DIY markets through 54 manufacturing and sales/service facilities with 7,200 employees located in North and Latin America, Europe and Asia Pacific. Our well-known brands have grown to 29, allowing us to service practically every industry with products and services that are continually improved, addressing the specific needs of our global customers.

The power tools offering counts with 17 reputable major brands like: **Airetool**<sup>®</sup> tube cleaners and expanders, **Apex**<sup>®</sup> fastening tools and universal joints, **Buckeye**<sup>®</sup> material removal tools, fixtured drills & power motors, **Cleco**<sup>®</sup> assembly and material removal tools, **Cooper Automation** automated fastening systems, **DGD/ Gardner-Denver** assembly equipment, **Doler**<sup>®</sup> advanced drilling equipment, **Dotco**<sup>®</sup> material removal tools and power motors, **Gardner-Denver**<sup>®</sup> assembly tools, hoists and power motors, **Gardotrans** modular transport systems, **Geta** fastening tools, **Master Power**<sup>®</sup> assembly, material removal and finishing tools, **Metronix** servos, drivers, speed controls, related electronics and software, **Quackenbush** advanced drilling equipment, **Recoules** drilling tools and cutters, **Rotor**<sup>™</sup> fixtured and portable assembly tools, and **Utica**<sup>®</sup> torque measuring and testing equipment.

A total of 12 world renowned and dependable brands presently comprise the hand tools offering. Brands like: **Campbell**<sup>®</sup> chains and wire rope grips, **Crescent**<sup>®</sup> wrenches, **Erem**<sup>®</sup> high precision cutters and pliers, **Kahnetics**<sup>®</sup> dispensing systems, **Lufkin**<sup>®</sup> measuring tapes, **Nicholson**<sup>®</sup> files and saws, **Plumb**<sup>®</sup> hammers, **H.K. Porter**<sup>®</sup> bolt, cable and strap cutters, **Weller**<sup>®</sup> soldering equipment, **Wire-Wrap**<sup>®</sup> wire wrapping equipment, **Wiss**<sup>®</sup> scissors, and **Xcelite**<sup>®</sup> screwdrivers.

Historically, CooperTools has been committed to the ongoing challenge to excel in every aspect of the business, from engineering and manufacturing to customer relations. We are dedicated to offering the very best technical solutions and service, with a strong focus on providing application solutions that increases product performance and our customer's profitability.



## About the authors

### **Bernd Polzer**

Bernd Polzer joined CooperTools, then Deutsche Gardner-Denver, in 1969. His first position was in the Standard Tools Development Department, where he played a decisive role in the development of Electronically Controlled Tightening Systems for the automotive industry. Subsequently, the scope of his responsibilities were increased, encompassing Sales and Marketing functions for fastening systems on a global level.

In 1994 he was promoted to Development Manager of the Westhausen operation, and has over the years supported CooperTools' global product development efforts.

Bernd Polzer currently holds the position of Manager, Business Development - Electronic Applications at CooperTools' European Headquarters in Westhausen, Germany, and is a participating member on the panel of various committees such as ISO, VDI, and DKD. These committees focus on the standardization of fastening technology.

### **Dr. Wolfgang Kofink**

After graduating in electrical engineering, Dr. Wolfgang Kofink worked as a scientific collaborator at the University of Stuttgart, Germany - in the project of electronically commutated electric motors, supported by the German Research Institute. After his doctorate in engineering he worked for several years as Research & Development Manager with well-known manufacturers of electric and tightening tools. Since 1994 he has served as a consultant to companies specializing in driving technology.

### ***Special Thanks***

*Our most sincere appreciation to B. Werthe Ing., Manager, Center of Competence for VW, Tightening Technology Worldwide, without whom this booklet would not have come to fruition. The collaboration received along with the research information placed at our disposal was vital to the outcome of this project.*

*B. Polzer*

*Dr. W. Kofink*

<b>1.</b>	<b>Introduction</b>	<i>6</i>
<b>1.1</b>	The Diversity of Assembly Tasks	<i>8</i>
<b>1.2</b>	Overview of Joining Techniques	<i>9</i>
<b>1.3</b>	Pulse Tool Development, Advantages & Disadvantages	<i>10</i>
<b>1.4</b>	CooperTools- Successful Marketing of Pulse Tools	<i>12</i>
<b>1.5</b>	Other Advantages of Pulse Tools	<i>15</i>
<b>1.6</b>	Efficiency	<i>21</i>
<b>2.</b>	<b>Principles of Threaded Joints</b>	<i>24</i>
<b>2.1</b>	Pre-load	<i>26</i>
<b>2.2</b>	Frictional Conditions	<i>28</i>
<b>2.3</b>	Relaxation	<i>30</i>
<b>2.4</b>	Tightening Factor	<i>31</i>
<b>3.</b>	<b>Joining Methods and Areas of Application</b>	<i>34</i>
<b>3.1</b>	Torque-Controlled Tightening	<i>35</i>
<b>3.2</b>	Angle-Controlled Tightening	<i>37</i>
<b>3.3</b>	Yield-Controlled Tightening	<i>39</i>
<b>3.4</b>	Joint Inspections	<i>42</i>
<b>4.</b>	<b>Functional Principle of Rotary Pulse Tools</b>	<i>45</i>
<b>4.1</b>	The Physical Relationships in Torque-Pulse Generation	<i>47</i>
<b>4.2</b>	Pulse Tools	<i>50</i>
<b>4.3</b>	Drive Systems	<i>53</i>
<b>4.4</b>	Shut-off Principles and Torque Adjustment Means	<i>54</i>



<b>5.</b>	<b>Behavior of Pulse Tools</b>	<i>59</i>
<b>5.1</b>	Threaded Joints	<i>60</i>
<b>5.2</b>	Torque Measuring Methods and Calibration	<i>62</i>
<b>5.3</b>	Vibration Levels	<i>66</i>
<b>5.4</b>	Noise Levels	<i>67</i>
<b>5.5</b>	Test Equipment for Tool Capability Auditing	<i>69</i>
<b>6.</b>	<b>Examples of Industrial Applications using Pulse Tools</b>	<i>70</i>
<b>7.</b>	<b>Future Developments</b>	<i>72</i>
<b>8.</b>	<b>Bibliography</b>	<i>74</i>

# 1. Introduction





## **1. Introduction**

Assembly technology is an essential component of modern industrial production, and threaded joints are among the most common and widely used types of fasteners. Detachable threaded fasteners have many advantages: They are ideal for recycling and conform to standard safety practices. Because these fastening processes are so widely used, their economic importance cannot be understated.

This booklet provides an overview of the fundamental principles for the major threaded fasteners and fastening processes, with a particular focus on the function and application of fastening pulse tools.

## 1.1 The Diversity of Assembly Tasks

The common industrial assembly tasks listed in Table 1.1 represent only a fraction of the many applications of threaded joints. The broad spectrum of assembly equipment ranges from state-of-the-art robotics to work stations using hand-held tools. The criteria for these assembly tasks are just as varied, depending upon the application needs, the production method, quantity and the accuracy requirements.

Table 1.1

Equipment	Branch	Product Examples
<ul style="list-style-type: none"><li>• angle-head tool</li><li>• wrench</li><li>• screwdriver</li><li>• fastening equipment</li></ul>	automotive industry:	cylinder head water pump generator shock absorber
<ul style="list-style-type: none"><li>• robot</li><li>• special equipment</li></ul>	electrical appliance:	television set refrigerator
<ul style="list-style-type: none"><li>• revolving transfer machine</li></ul>	electronics:	tape recorder VCR calculator
<ul style="list-style-type: none"><li>• transfer line</li></ul>	mechanical engineering:	hydraulic pump electric motor

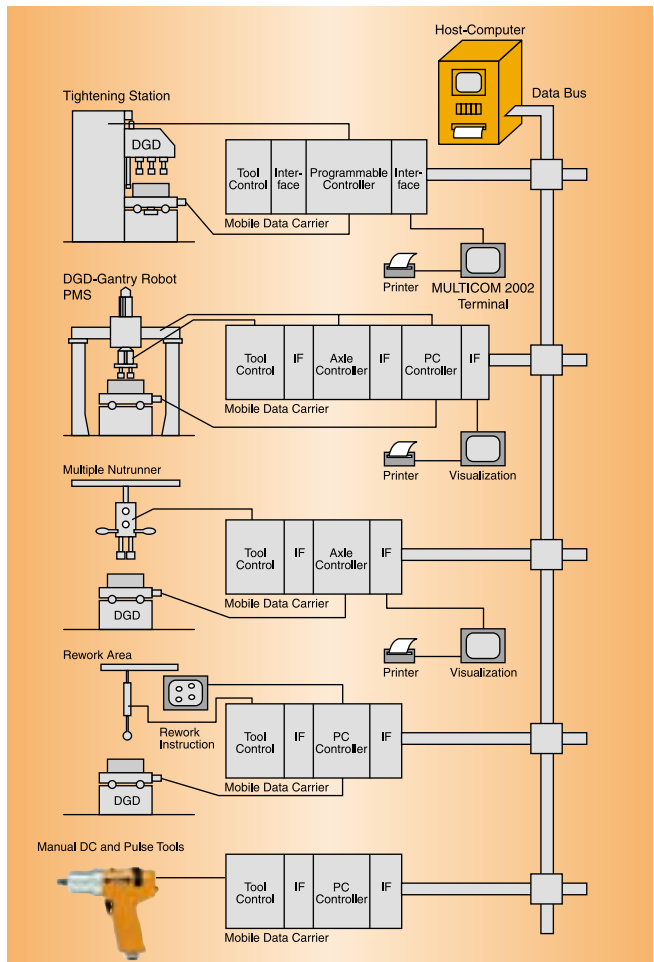
## 1.2 Overview of Joining Techniques



Conventional fastening requires tools like a wrench or an electric or pneumatic tool. Industrial assembly or joining technology increasingly requires meeting long-term safety-oriented, and function-oriented solutions.

Fig. 1.2 shows the most common equipment used in an assembly line for joining threaded fasteners, such as tightening stations, robots, multiple nutrunners, rework areas, manual DC and pulse tools.

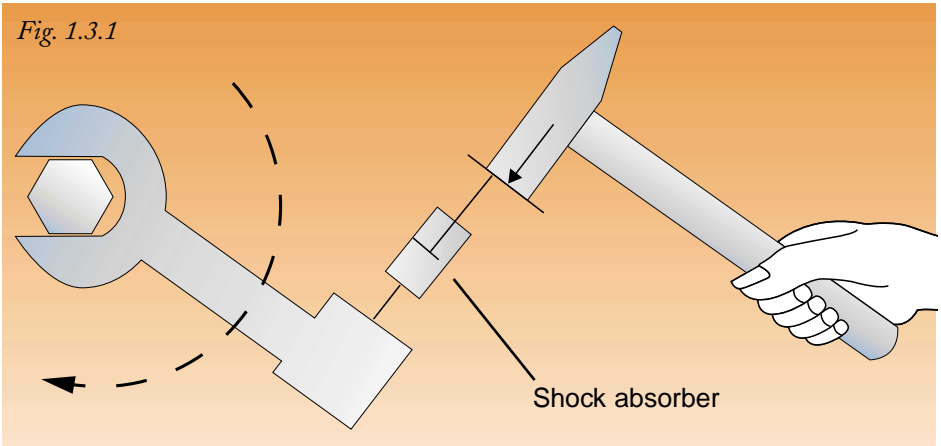
Fig. 1.2



### 1.3 Pulse Tool Development, Advantages and Disadvantages

Historically there have been disadvantages associated with the use of impact wrenches such as inaccurate tightening, high tool wear, and noise levels for operators. In the Sixties, these disadvantages led to the research, development, and patenting of tools with a hydraulic pulse module. These new pulse tools utilized the advantages of impact tools, such as the low torque reaction, fast tightening, and low set losses while reducing the tool wear and noise levels. In simple terms, a pulse tool is an impact wrench with an integrated hydraulic shock absorber.

Fig. 1.3.1 illustrates an elementary diagram of a pulse tool.



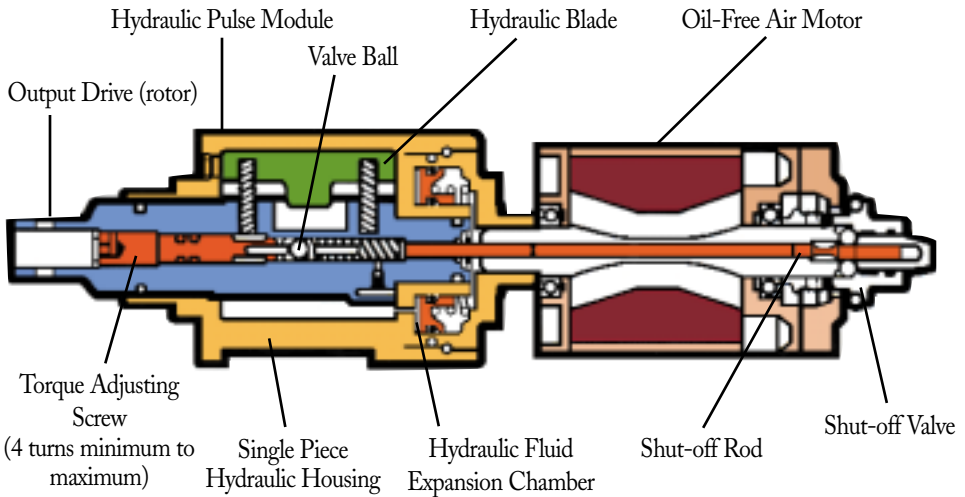
One of the first inventions in the field of pulse tools led to a patent application in 1964 in the United States. The first marketable pulse tools were produced in Japan.

In the early Eighties, CooperTools developed and successfully marketed a much-improved line of pulse tools with a number of new features. Fig. 1.3.2 show the cross-section of the drive and hydraulic pulse module of a tool.



The basic principles of the original concept are still evident in all of today's pulse tools. Their function can be explained like this: The external cylinder of the hydraulic pulse module is driven by a motor, and after each revolution, when the chambers are sealed by the blades, its kinetic energy is transferred as an impulse to the output shaft. Further explanation of these principles can be found in Section 4.2.

Fig. 1.3.2



## 1.4 CooperTools- Successful Marketing of Pulse Tools

CooperTools has been an innovator in developing and marketing pulse tools for over a decade. This constant and progressive development has decisively shaped and heightened industry standards in the areas of extraordinary efficiency, longevity, and minimizing downtime. The combination of our technology coupled with the robust quality of our Cleco® tools, has helped CooperTools attain a leading position and significant recognition in the international marketplace. This recognition is attributed to the ability of all Cleco tools to attain catalog torque ratings for both hard and soft joints.

CooperTools has historically maintained a sales strategy for pulse tool products, focusing primarily on the shut-off tool market. The outcome of our most recent development efforts is a new generation of non-shut-off pulse tools. These new tools are offered in pistol grip and in-line models ranging from 2.6 to 400 Nm, and from 7 to 17 Nm respectively. Refer to Fig. 1.5.1.

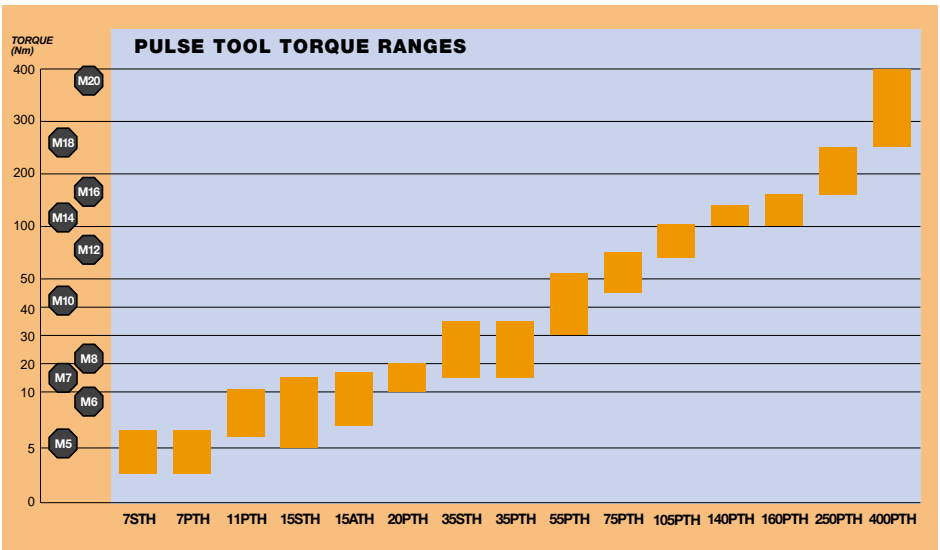
*Fig. 1.5.1*






While conventional impact tools are still being used in considerable quantities in general industries, the new non-shut-off pulse tools from CooperTools represent a major innovation. They provide a considerable advance in fastening technology through numerous ergonomical and technical features, developed and produced with CooperTools' quality. The new generation of shut-off pulse tools are currently available for torque ranges from approximately 2.6 to 400 Nm as shown in Fig. 1.5.2.

Fig. 1.5.2





Shut-off pulse tools can cost up to 3 - 4 times more than an industry quality impact tool, depending on torque range. CooperTools' range of new generation pulse tools offer the industry a solution that mitigates increasing costs, while maintaining excellent quality and performance levels.

Current industry requirements demand that tools offer the following:

- One hand operation
- Extended service life
- Operator comfort
- High torque range
- Low torque reaction
- Ease of serviceability to minimize downtime
- High value versus Low cost

It has been CooperTools' long-standing practice to test every tool before it leaves the factory. Furthermore, our ISO 9000 certification guarantees that all products are precisely tested in the following areas: visual examination; maximum torque levels on hard and soft joints; rotational speeds; noise levels and air consumption. Once testing is completed, tools are optically marked with pertinent tool characteristics using permanent laser technology.

CooperTools has acquired a significant amount of experience in the fastening tool industry through research and development. In the process, achieving and improving on "operator comfort" has been a driving force. The success of our Cleco pulse tool line is a leading example of a tool that achieves further operator comfort by consistently offering lower stress levels without compromising performance.

## 1.5 Other Advantages of Pulse Tools



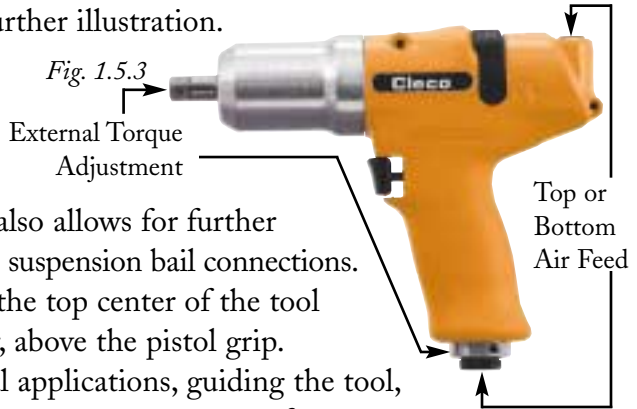
Additional pulse tool advantages benefiting the operator are outlined below.

### Optimum workstation configuration:

CooperTools' Cleco pulse tools offer housing grips with two air inlets. This innovation allows compressed air to be fed either from the top or bottom, therefore increasing flexibility and enhancing tool ergonomics. This increased flexibility allows completely new workstation configurations. Refer to Fig. 1.5.3 for further illustration.

### Vertical and horizontal suspension:

Cleco pulse tool design also allows for further flexibility by offering two suspension bail connections. These are positioned at the top center of the tool and the other at the rear, above the pistol grip. For horizontal or vertical applications, guiding the tool, in its "preset" position can minimize operator fatigue, increasing performance and efficiency.



### Minimum cooling in operator's hand:

An effective grip-insulation reduces the known grip-cooling problems that occur with compressed air tools. The temperature drop, which occurs when compressed air expands, does not extend through the grip-insulation to the palm of the operator's hand (Fig. 1.5.4). This minimum cooling feature increases the operator's comfort and performance.



### **Dual handle sizes:**

The Cleco pulse tools are available for the first time in two handle sizes. Whether the operator has small or large hands, the ergonomic design of the grip area and its ability to adapt to different hand contours, provides for optimum clasping of the tool. The various handle sizes captures up to the 95th percentile for hand sizes. This design feature prevents finger cramping and fatigue.

### **Minimum reconfiguration time:**

CooperTools' pulse tools are equipped with a square output shaft or a quick-change chuck. By changing the socket wrench attachment, fasteners or nuts ranging in size can be run down with minimum reconfiguration time.

### **Robust housing design:**

Today's assembly applications require the tool to return to its holster on the workbench after each operation. This repetitive motion can increase the possibility of damage to the reverse button. Cleco has designed its tools with a housing ramp design that protects the reverse lever from external damage. This design increases the tool's service life, reduces repair costs, and improves handling.



*Fig. 1.5.5*



### **Lower compressed air consumption:**

A common problem in today's industry is the increasing cost of compressed air. Cleco offers a dual chamber design that optimizes the use of compressed air. This is accomplished by increasing the number of rotor blades. This reduces revolving rotor mass, allowing the rotor to accelerate faster, transfer energy more uniformly, and produce a considerable amount of increased torque.

### **High tolerance of compressed air quality:**



Cleco pulse tools work regardless of whether compressed air is generated by oil-free or oil-lubricated compressors. It is important to remember, however, that oil free does not mean "non-lubricated".

### **Adjustable torque:**

Cleco tools come with a scaled aluminum ring located at the handle air inlet. This allows the tool torque to be precisely adjusted for the required fastening operation. This feature is applicable regardless of whether the air is fed to the tool through the top or bottom inlet, as the design controls the airflow of the exhaust.

### **Increased life cycle:**

The Cleco pulse tool design allows air exhausted from the dual chamber motor to cool the adjacent pulse unit. This insures that the correct viscosity of the oil is always maintained. Our patented hydraulic expansion chamber extends service life and reduces maintenance costs by allowing for longer oil refill intervals (e.g. 500 hours or 200,000 fastenings). The unique design of the expansion chamber allows the hydraulic fluid to expand and contract as the tool performs.



*Fig. 1.5.6*  
excellence and innovation is the development of Cleco pulse tools, available in both pistol grip as well as in-line models with an integrated suspension bail.

Once again, the principles of ergonomic tool design were applied, producing a product offering reduced weight and an improved grip area covered in plastic. These features provide a unique shock-absorbing function that significantly decreases vibration.

Particularly in assembly applications, sensitive control of the initial force via the start lever is essential. Cleco pulse tools produce especially high rotational speeds of up to 9,000 rpm. This allows the tool to operate with extremely efficient cycle times through very short rundown times.

### **No "white hands":**

“White hands” are no stranger to the experienced operator. The coldness and numbness that can be caused by a poorly designed tool is

### **Lower noise levels:**

Conventional impact tools operate with mechanical contact of a hammer and anvil.

Cleco pulse tools operate without the need for metal impact, therefore reducing noise levels below 72 dB(A).

### **In-line models:**

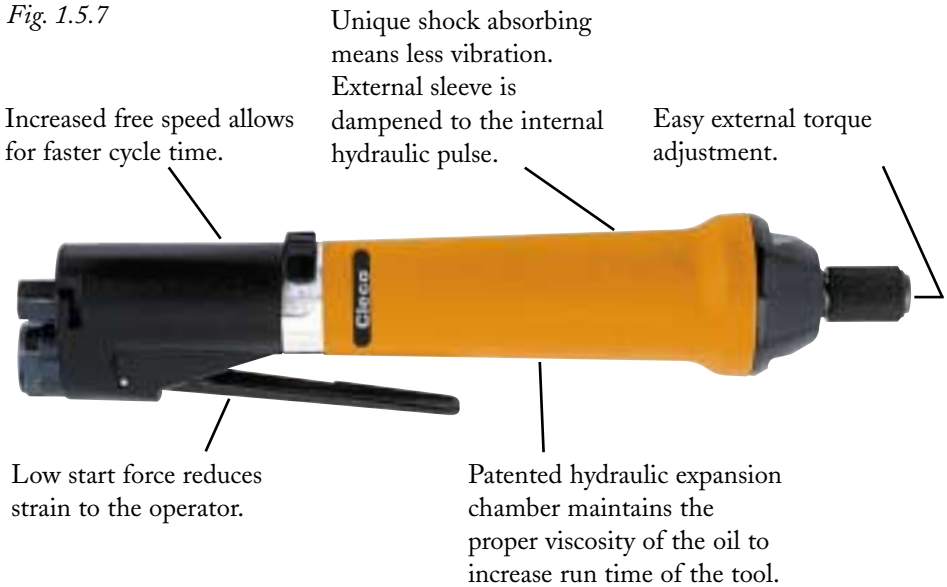
CooperTools thrives on the challenge of achieving optimum solutions for fastening tasks and applies this "motto" throughout. A prime example of our continuous search for

excellence and innovation is the development of Cleco pulse tools, available in both pistol grip as well as in-line models with an integrated suspension bail.



extremely unpleasant. Cleco pulse tools are designed with a sensitive “soft start” start lever and complimented with a highly effective rubber covering of the grip area. Combined, these features increase the absorption and reaction of tool vibration, relieving the operator from unnecessary strain.

*Fig. 1.5.7*




### **Shut-off angle pulse tools:**

When using shut-off tools that develop up to 10 Nm of torque for M5, M6 and M7 fasteners, the disadvantage of torque reaction for the operator cannot be prevented. For these applications, the new Cleco angle pulse tools are the solution - reducing the torque reaction of a shut-off tool to the minimum.

### **Advanced shut-off pulse tools:**

Analyzing the success of the newly redesigned ergonomically improved handles, it was evident that applying this improved feature to our existing



shut-off pulse tool line would further enhance the product benefits already offered by the initial design. Therefore, CooperTools now offers their shut-off and non-shut-off tools spanning over the entire torque range up to 400 Nm with this option. Top and bottom air feed inlets are also an added bonus.

### **Easy torque adjustment:**

In addition to enhanced ergonomic handling of our tools, our design also allows torque to be adjusted with minimum effort. Torque adjustment does not require disassembly of the tool, as seen in figure 1.5.7. Inserting an Allen wrench in the output shaft is all that is required. This feature enhances productivity by reducing downtime when adjustments are necessary.

### **Service-friendly design:**

The assembly industry relies greatly on dependable products that can enhance productivity while addressing budgetary concerns. With this in mind, CooperTools has designed their non-shut-off pulse tools with a design that allows for standard maintenance tasks that can be performed easily and quickly, without any special training or special tools.

### **Training courses:**

CooperTools also offers training courses to service staff at our facility, as well as on-site training. Some of the topics covered in these training courses are focused on performing tasks like refilling oil, service and maintenance of tools.



## 1.6 Efficiency

Pulse tools, by definition, have the ability to run down a fastener significantly faster than an electronically controlled (EC) tool, due to its relatively high free speed. Research indicates that the rundown time can be reduced by approximately 35%, therefore increasing productivity. Fig. 1.6.1. offers a comparison of the two tools.

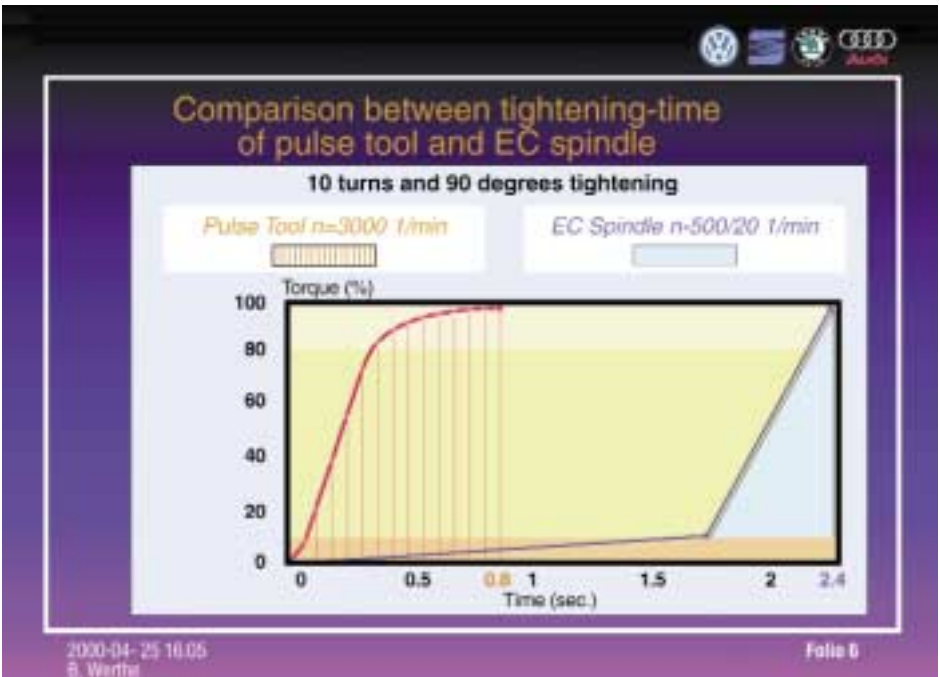


Fig. 1.6.1

Figure 1.6.2 shows the added value and cost-saving potential of a threaded joint assembly using a screwdriver and tightening with wrench compared to assembly with an EC pulse tool. The timesaving potential in this concrete example amounts to 40%. The value added improves from 10% to 17%.

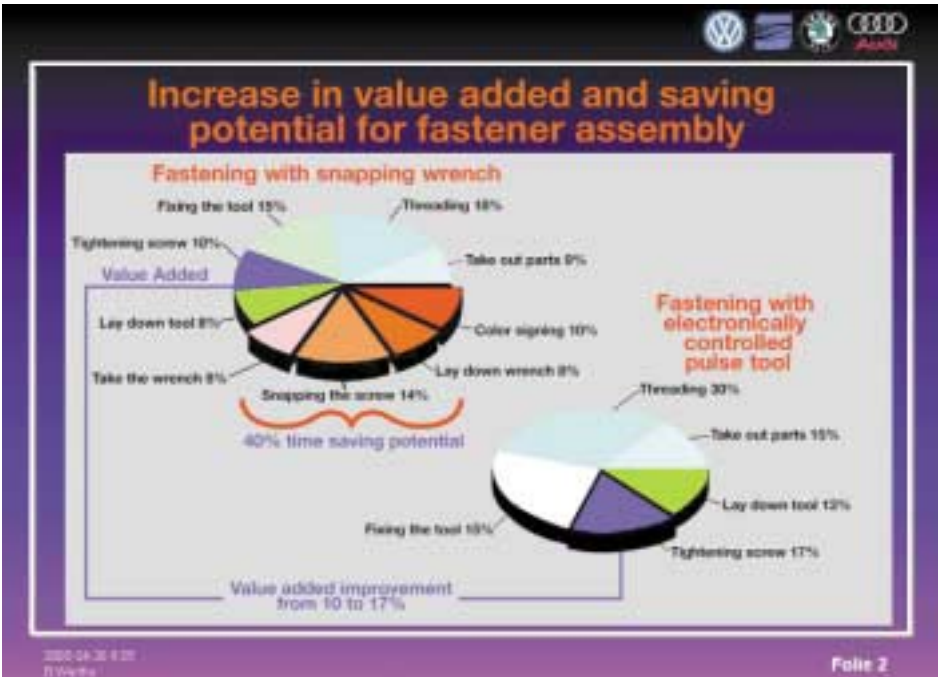


Fig. 1.6.2



Additionally, an electronically controlled pulse tool can be used economically for over-elastic fastener assembly. Fig. 1.6.3 shows the low pre-load scatter results.

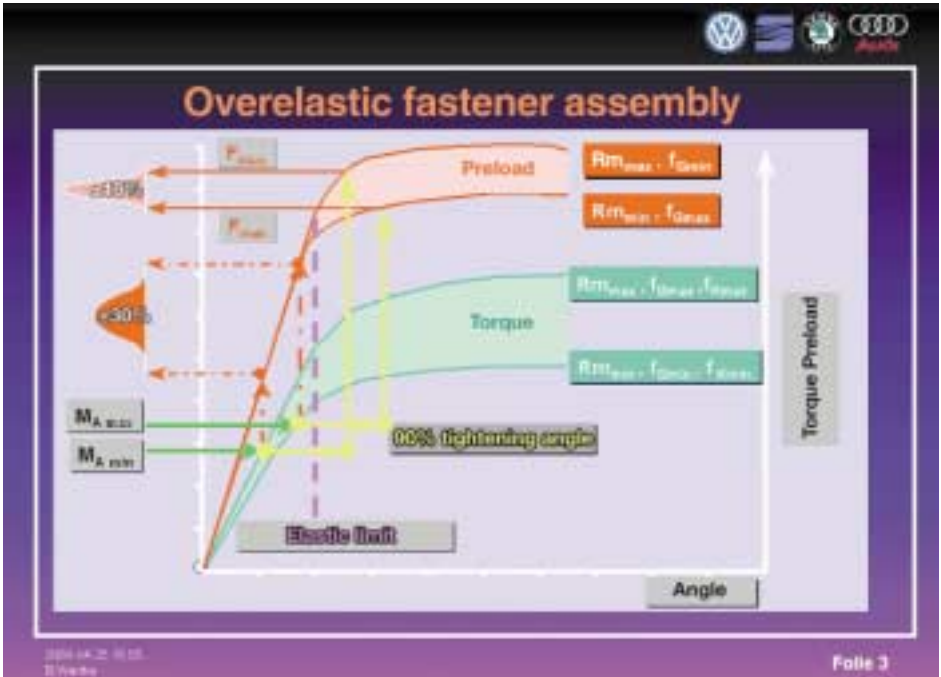
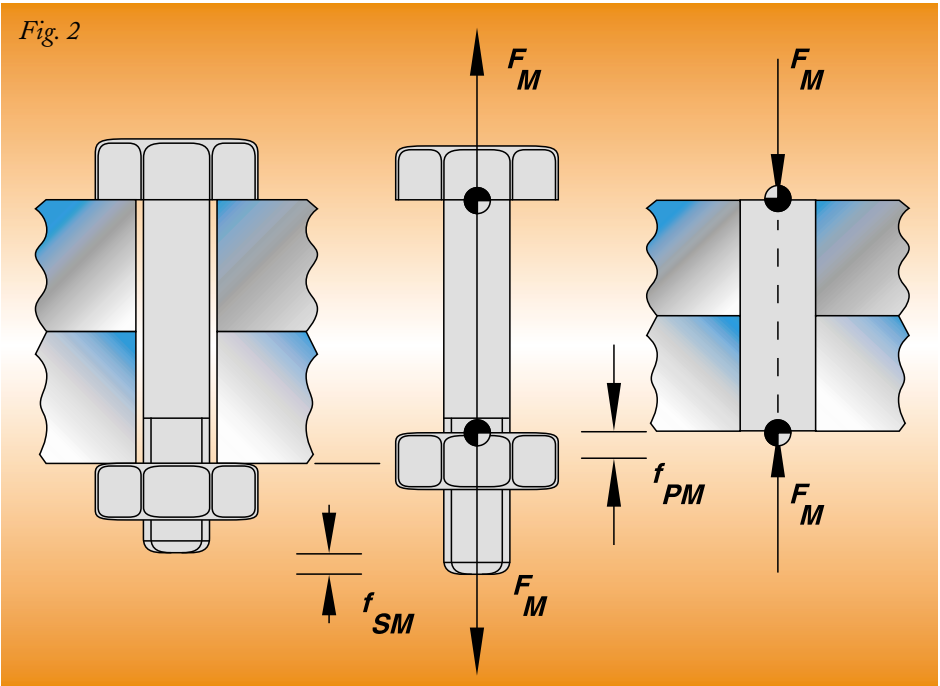


Fig. 1.6.3

# **2. Principles of Threaded Joints**



Fig. 2 illustrates the moments and forces of a bolted joint without an applied load.



A bolt is quite simply a fastener that has a thread, which does not extend all the way to the head and is designed to be used with a nut. Without a working load, the bolt is merely a clamping device, where the plates are the clamped parts. In a bolted joint, the parts to be clamped are pressed together by the clamping device. The bolt pre-load  $F_v$  is equal but opposite to the pre-load of the clamped parts. In the assembly state without an external load, the assembly pre-load ( $F_m$ ) is identical with the bolt force ( $F_s$ ). The assembly pre-load ( $F_m$ ) in the clamped parts is identical with the clamp force ( $F_k$ ).

## 2.1 Pre-load

### 2.1.1 Bolted Joint without Applied Force

The effect of assembly pre-load  $F_m$  is extended as a bolt is tightened, producing clamp force  $F_k$  and compressing the clamped part(s). The bolts small cross section causes further extension. (Joint compression of the clamped part(s) is less than the bolt extension). Extended bolt  $f_{sm}$  occurs when assembly pre-load  $F_m$  is applied. Clamped parts are compressed by  $f_{pm}$  resulting from tensile forces. The relationship of Force  $F$  and linear change is further explained in Fig. 2.1.1 below.

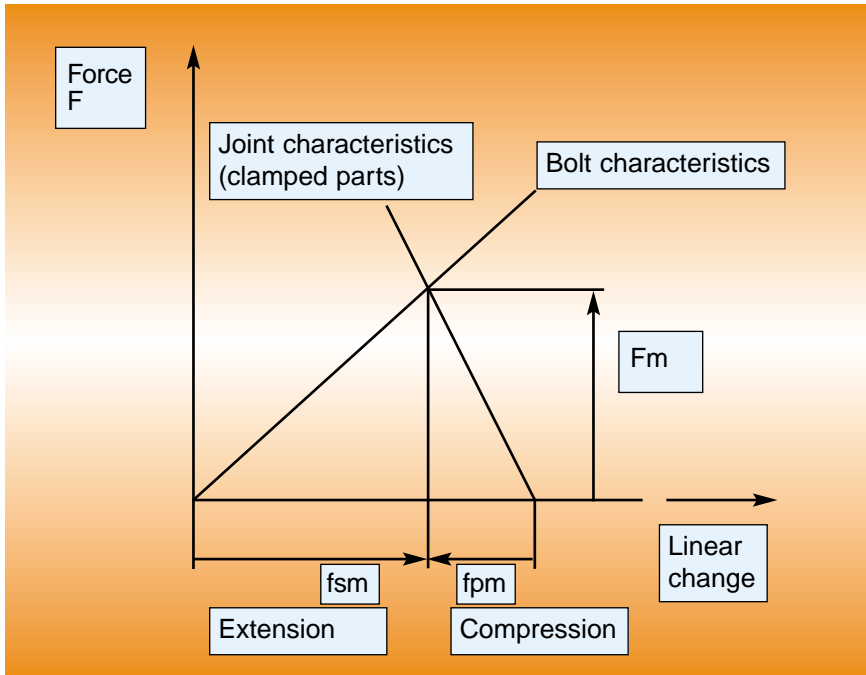


Fig. 2.1.1



## 2.1.2 Bolted Joint with Applied Force

When an external tensile force ( $F_{sa}$ ) is applied to the bolted joint it has the effect of reducing some of the clamp force caused by the bolt's pre-load ( $F_m$ ) and applying an additional force to the bolt itself. The external force acts through the joint material and then subsequently into the bolt. As a result, the bolt is further extended by length ( $f_{sa}$ ) and compression ( $f_{pm}$ ) is reduced by  $f_{pa}$ . The clamped parts are relieved by the axial force ( $F_a$ ) while the residual clamp force ( $F_{kr}$ ) sustained by the clamped parts, is retained. The load on the bolt cannot be added without decreasing the clamp force acting on the joint. Therefore, when designing a bolted joint, a sufficient residual clamp force must be retained, otherwise the joint may loosen. Fig. 2.1.2 illustrates these relationships.

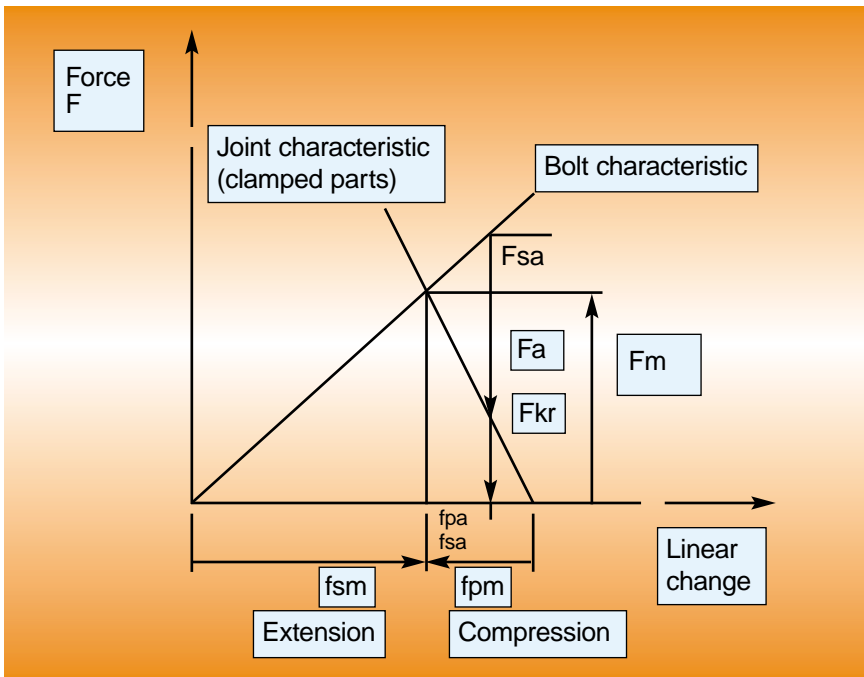


Fig. 2.1.2

## 2.2 Frictional Conditions

As described in Section 2.1, pre-load is the main factor for a securely bolted joint and different pre-loads can be produced for any bolted joint. However, in most cases, pre-load can only be measured under laboratory conditions. Therefore, it is necessary to fall back on tightening torque to define and test bolted joints.

Consideration to the geometry of a bolted joint is essential. For example: The thread lead angle  $\alpha$ , the ratio of torque to pre-load, the coefficients of friction  $\mu$  of the thread and the bolt head/nut face must also be considered as described in the formula below.

$$Md = \text{function of } F_m, \alpha, \mu_k, \mu_g, d_{km}$$

In this instance, a frictional scatter can pose a serious problem. A reminder that different pre-loads can be produced for any bolted joint.

The relationship between torque and pre-load for two coefficients of friction is further described in Fig. 2.2.1.\* This illustrates the distinct variance in torque for the given pre-load required for a bolted joint, reinforcing the fact that the pre-load can scatter considerably for an accurately tightened bolt.

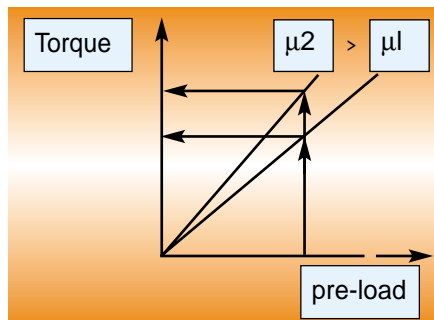


Fig. 2.2.1

\* To simplify the diagram, thread friction and head/nut face friction are considered identical.



Frictional effects can be created by various factors including rough, smooth, and greased surfaces, machining residue, shavings, etc.

Fig. 2.2.2 shows the factors influencing the joining process and pre-load.

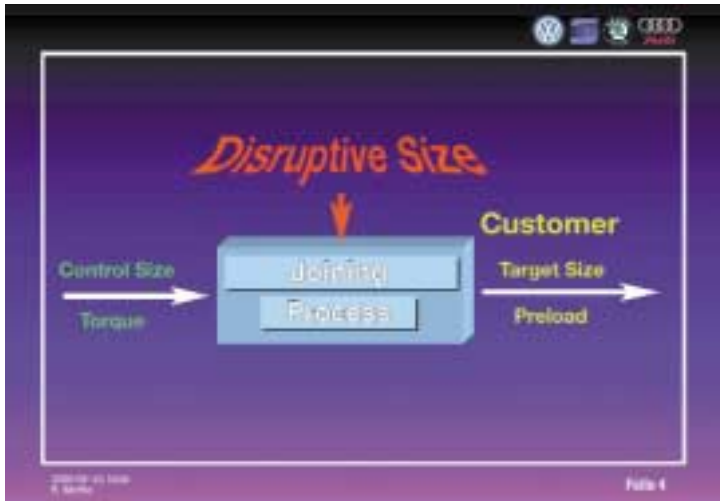


Fig. 2.2.2

Fig. 2.2.3 shows the efficiency of a bolted joint divided as follows:

- Bolt head/nut face friction
- Thread friction
- Pre-load

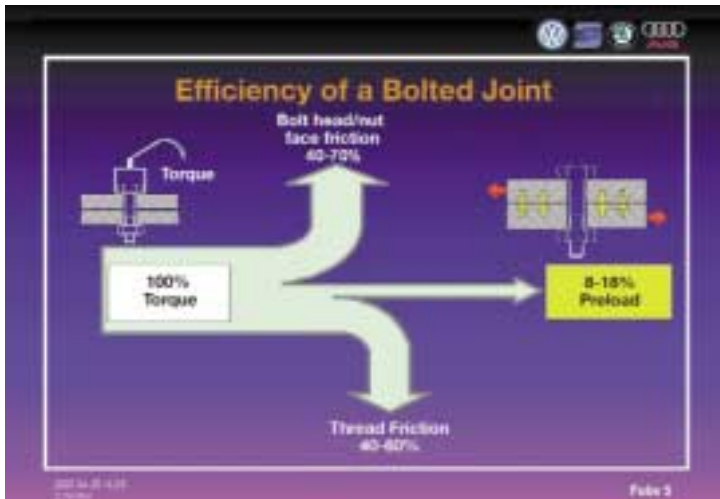


Fig. 2.2.3

All points covered above are elements crucial for the joint.

## 2.3 Relaxation

The effect of bolt-joint relaxation is another important influence that can affect pre-load. It is said that a bolted joint "relaxes" when the original clamp force value drops to a lesser value over a certain period of time. Relaxation is caused by elastic yielding of the joined materials under the bolt head and in the parting line. Materials such as gaskets, coatings, paint, wax, etc. are predominantly more predisposed to this effect. Poor joint design can also contribute to relaxation, caused when the material is exposed to pressure at the contact area.

Fig. 2.3 shows an example in which the assembly pre-load ( $F_m$ ) is reduced by an amount of relaxation ( $F_z$ ).

There are three considerations that should be addressed that can limit "relaxation". These are:

- Decision-making and selection process of appropriate materials and proper joint design.
- Tightening speed and the period of time for the rundown process.
- Selecting pulse tools as the fastening device, due to the short impulses and long impulse frequency.

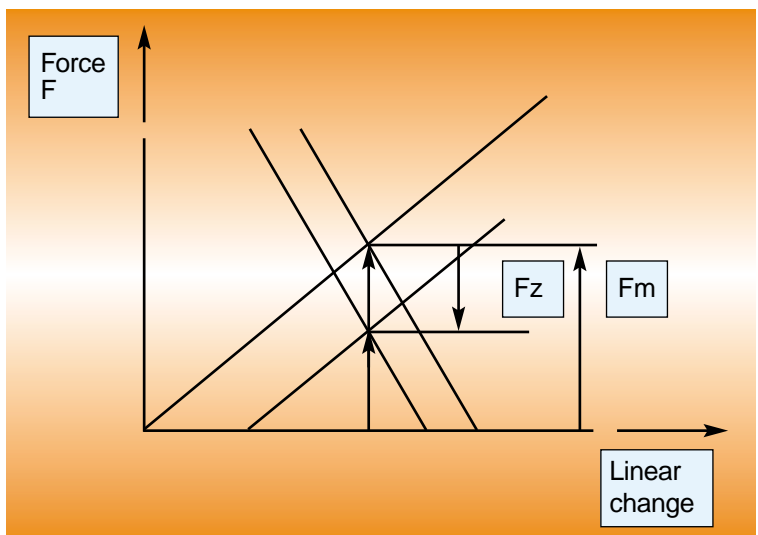


Fig. 2.3



## 2.4 Tightening Factor

The tightening factor is a measure of the scatter in a bolt's clamp force as a result of the tightening method used to tighten the fastener. The tightening factor is defined as the maximum bolt clamp force divided by the minimum value anticipated for that tightening method.

If several bolts of the same size are tightened by the same method, then there will be variation in the bolt's pre-load - not all will have the same value. Various factors lead to more or less pre-load assembly scatter. These discrepancies are influenced by such factors as variation in friction characteristics in the thread and under the nut face, thread form and pitch variations, variations in the surface flatness, accuracy differentials in tightening methods, operational errors, read-out errors, etc. For any particular tightening method there will be a maximum anticipated pre-load and a minimum, given a set of conditions.

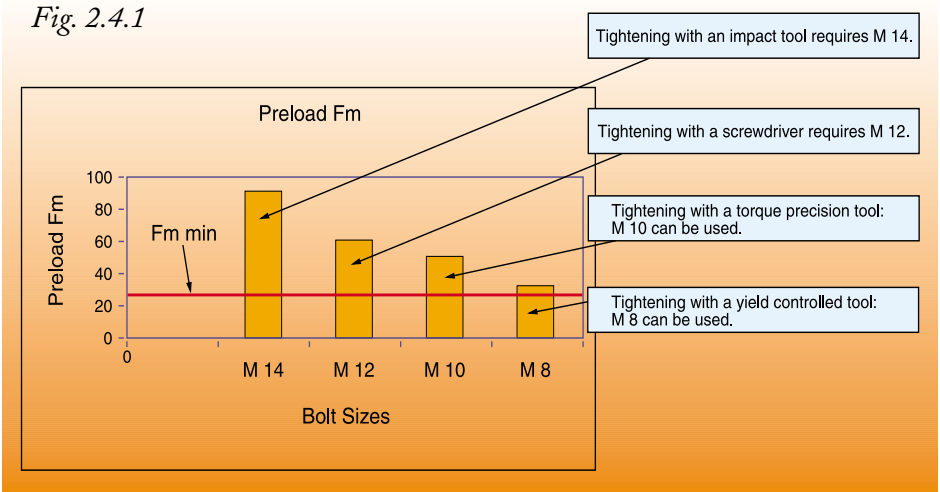
In order to provide a means to evaluate different fastening methods and their accuracy, a tightening factor must first be defined as shown in the formula below. This will allow an assessment of tightening methods used in fastening technology.

$$\alpha = \text{Maximum pre-load} / \text{minimum pre-load}$$

The maximum pre-load must not lead to joint failure (e.g., bolt fracture). The minimum pre-load must ensure that the bolted joint does not loosen. An increasing tightening factor  $\alpha$  indicates that a larger bolt cross section, i.e., a larger bolt, must be used at the same minimum pre-load.

Fig. 2.4.1 shows an example of the bolt size, pre-load scatter ( $F_m$ ) at a minimum pre-load for different tightening methods.

Fig. 2.4.1



Bolt range:

M 14: tightening with an impact tool

M 12: tightening with a screwdriver

M 10: tightening with a torque or precision tool

M 8: tightening with a yield-controlled tool



The table below itemizes tools and tightening methods with their corresponding tightening factors:

Type of Tool	Tightening Method	Tightening Factor
Impact	torque-limited	2.5 - 4
Shut-off	torque-controlled	1.3 - 2.5
Pulse	torque-shut-off	approx. 2
Shut-off	angle-controlled	1*
Shut-off	yield-controlled	1*
Pulse	yield-controlled	approx. 1.3

\* Torque scatter mainly results from the yield point scatter in assembled bolt batches.

Fig. 2.4.2 shows the relationship between pre-load scatter and the tightening factor.

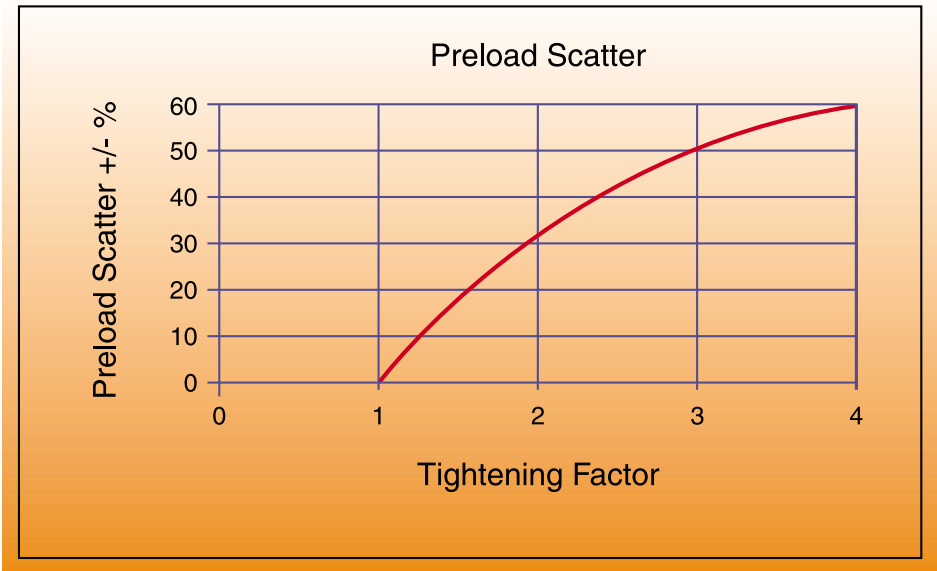


Fig. 2.4.2

# **3. Joining Methods and Areas of Application**



The primary purpose of using threaded fasteners in a joint is to prevent gaps, to seal, or to provide frictional grip. This is achieved when a clamping force that is greater than the applied working load is created.

While the measurement of the clamping force is technically possible using methods such as: measuring with a load cell under the bolt head; measuring bolt elongation with a strain gauge; ultrasonic interference detection; or use of a central gauge pin slipped down a hole drilled inside the bolt. The implementation of these methods is both time-consuming and expensive and can only be justified in special cases.

When tightening in actual production, selecting easily measurable values of torque and angle of rotation is a more effective approach.

### **3.1 Torque-Controlled Tightening**

Torque, measured through a torsion shaft is the most readily accessible measuring value in threaded fastener joining technology. The pre-load produced by a torque-controlled tightening process depends on the friction scatter under the bolt head, friction scatter on the thread, and torque scatter of the fastening tool.

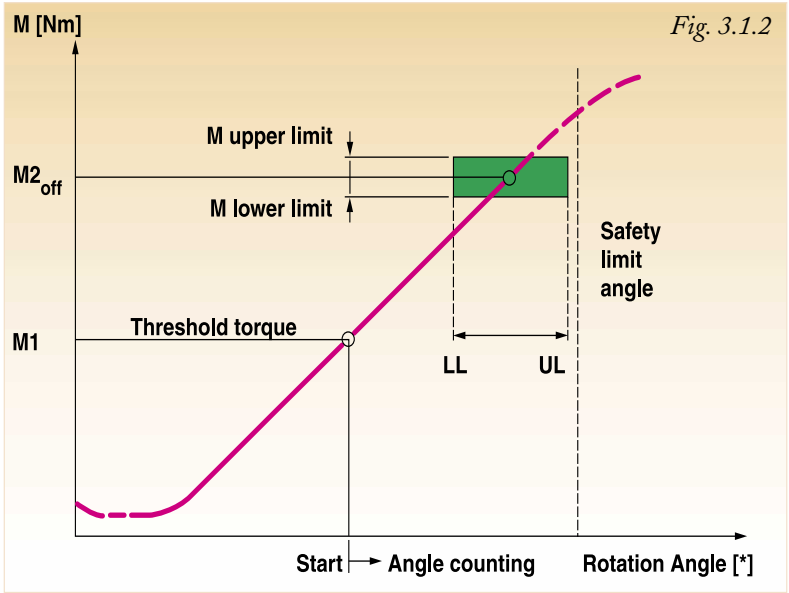
#### **3.1.1 Simple Tightening Processes**

Limiting torque is a simple process. On manual tightening tools, torque can be limited by a shut-off clutch. On air shut-off tools, torque is limited by air pressure. On electric tools, torque is limited by turning off the electric power to the motor.

#### **3.1.2 Electronically-Controlled Tightening**

Selecting appropriate tools equipped with sensors and electronic controls can easily control and limit torque scatter. An additional benefit is the ability to monitor joint friction through angle detection.

Rundown results displayed within an "OK window" specified by torque and angle limits can ensure that the clamping force of a joint only scatters within allowable limits. Fig. 3.1.2 shows a rundown using torque control.



Coating the fastener with friction stabilizers - waxed or oiled - can assist in reducing frictional area and therefore reduce the rotational angle range. If bolt extension within the elastic range is desired, it is possible to achieve by allowing sufficient distance from the maximum tensile strength  $R_{m\ max}$ . Anticipating the extent of friction and torque scatter may prove to be an important determination. This implementation forces the bolt to extend within its elastic range by using torque-controlled tightening. Testing with a torque wrench for confirmation can be performed.

Torque-controlled fastening is suitable in those applications for which a permissible clamping force scatter can be projected in the joint design.



## Summary of Torque-Controlled Fastening

### Advantages:

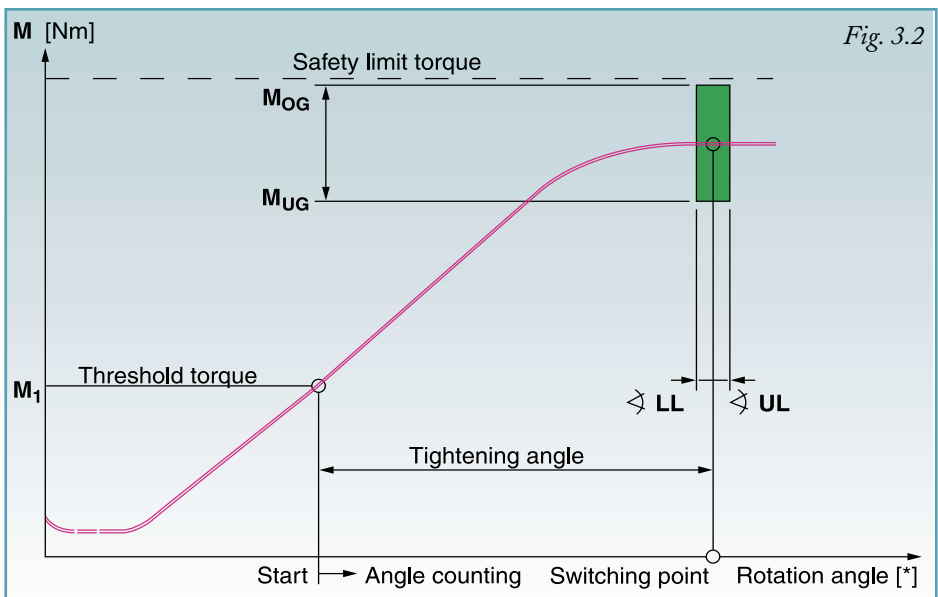
- Torque is easy to measure and control
- Inexpensive fastening tools are available
- Torque can be subsequently examined


### Disadvantages:

- Tightening factor depends on the tool and monitoring procedure used
- Bolt size is 1.5 to 2.5 times as great
- There is a corresponding clamping force scatter

## 3.2 Angle-Controlled Tightening

Angle-controlled tightening requires a fastening tool equipped with angle and torque sensors and the necessary electronic controls. Fig. 3.2 shows a rundown process using angle control.





In order to maximize this process, the fastening point should be as rigid as possible, while the bolt should be appropriately flexible. For this process, it is recommended to use undercut fasteners with at least three threads, and shank extension fasteners.

In angle-controlled tightening the bolt is extended beyond its yield point into the flat segment of its stress-strain characteristic. The required angle at a given threshold moment is established by calculation or experimentation. The pre-load attained by this process no longer depends on head or torque scatter, but only on the stress area, the clamping length, thread friction, and fastener strength. The greater plastic elongation allowed in this fastening method prevents repeated application of the fastener and reapplication is permitted only under limited and restrictive conditions.

Angle-controlled tightening can be applied wherever the bolt is the weakest element of the joint. Permanent deformation occurs in the free, non-tensioned thread or in the shank.

### **Summary of angle-controlled fastening**

#### Advantages:

- Relatively constant clamping force, generally independent of friction and torque scatter
- Easy to reproduce in a workshop or during service

#### Disadvantages:

- Extensive measuring required; fastening tool must be equipped with torque and angle sensors
- Joint must be of sufficient proportions
- Greater tool capacity required
- Limited reapplication of fastening elements must be taken into account during service to utilize dimensional advantages

### 3.3 Yield-Controlled Tightening



Another tightening method is termed yield-controlled fastening. With this process, torque increase is constantly calculated by means of a fixed angle increment while the bolt is being tightened.

As long as the bolt is being extended within Hook's line, the moment slope is constant. Once the limit of proportionality of the fastener material is exceeded, the moment slope over the angle increment decreases. The mathematical explanation is as follows: the first derivative of curve  $M = f(\varphi)$  is formed and the function remains constant as long as the  $M$  slope is constant, but drops when the  $M$  slope levels off. When the gradient reaches a calculated drop, generally about 50%, tightening ceases.

This tightening process allows the fastener to be extended to its precise yield point. Thus, a constant clamping force that is independent of friction and moment scatter, and, therefore, only dependent on the achievement of fastener specifications. Since the elongation of the bolt is so small (only approximately 0.2% of the clamping length), the bolt can be used repeatedly. However, the elongation is sufficient to allow yield point detection by length measurement.

The conception of yield-controlled tightening methods presented the additional problem of resolving varying friction and varying fastener specifications. The  $M = f(\varphi)$  curve is demonstrative of a different maximum gradient  $\Delta M / \Delta \varphi$  for higher and lower friction values. Fig. 3.3 shows a tightening process using yield control.

To ensure the least bolt extension, the shift gradient must be near the maximum gradient. Likewise, the shift gradient must be far enough from the maximum gradient to prevent early shut-off. If an irregular moment curve caused by friction changes or stick-slip effects occurs, early shut-off may result. Applying a shift gradient of 40%-60% of the maximum gradient can satisfy both requirements.

This process was found to be impractical and is currently considered insignificant.

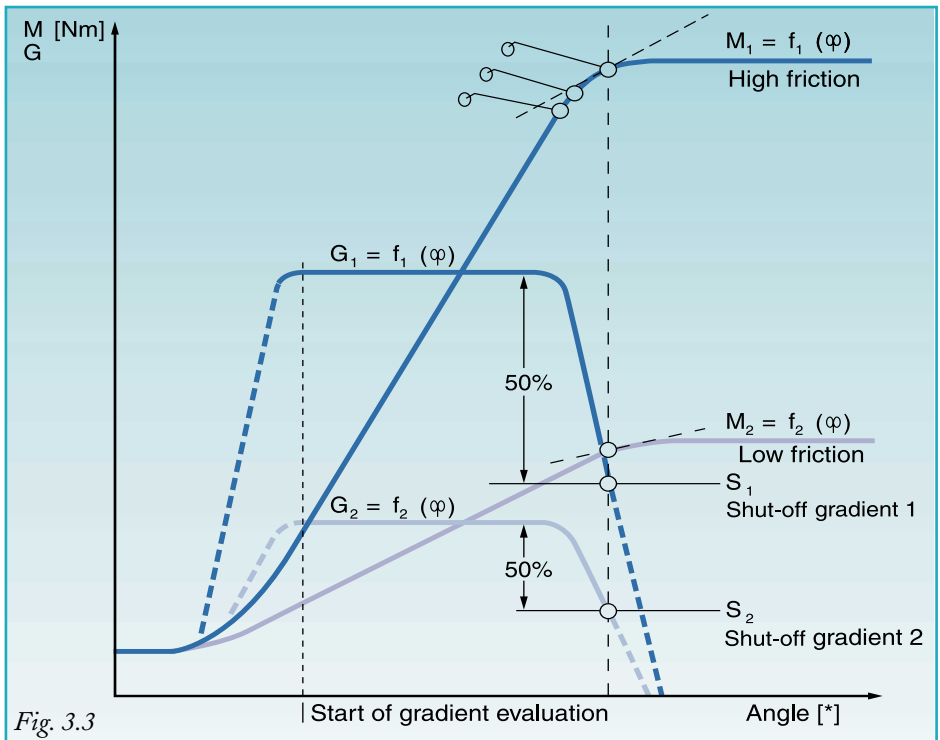


Fig. 3.3

In applications where no components reach their yield point before the fastener, such as washers or work-piece parts, the yield-controlled fastening process can prove to be beneficial. This approach insures that no special demands are placed on the bolt. Furthermore, as a result of low elongation, an extension length of approximately 2 - 3 free threads is considered adequate. This is a proven method to achieve high pre-load consistency, eliminating the concern for friction or torque scatter.



## Summary of Yield-Controlled Fastening

### Advantages:

- Uniform pre-load, relatively independent of friction and moment scatter
- Small bolt cross-section corresponding to tightening factor = 1
- No special fastener type required
- Bolt can be used repeatedly

### Disadvantages:

- Extensive electronic measuring and evaluation required
- Expensive equipment required
- Product service requires advanced fastening capability
- Special Tightening Processes

While torque, angle, and yield-controlled tightening methods belong to the realm of standard fastening processes, there are also special tightening methods devised to address specific fastening needs. These special methods are designed to perform pre-determined rundown cycles and guarantee secure joints. Several of these special tightening processes are listed below. (Detailed information on this subject exceeds the scope of this document and is readily available elsewhere.)

- Loosening/tightening processes for plastic coated parts or fasteners
- Processes with multiple tightening stages, e.g., for tapping fasteners
- Envelope-curve monitored processes, e.g., for lock and jam nuts

Ultrasound processes which require additional angle and torque monitoring besides the ultrasound control; fasteners must be especially made for this method and are more expensive than conventional threaded fasteners.

## 3.4 Joint Inspections

The process of confirming that a joint is properly tightened can prove to be a challenge. A common scenario when testing is a situation where various threaded fasteners, like setscrews and bonded fasteners cannot be loosened or tightened. If a scenario of this type is encountered, then the test cannot be performed unless it is certain that no damage will be caused.

Nevertheless, it is sometimes necessary to test tightened joints for torque accuracy. These cases include:

- Analysis of unknown torque
- Joint inspection through documentation of residual torque tests, e.g., for ISO 9000
- Detection of changed joint characteristics
- Detection of bolt-joint relaxation and embedding effects, especially in series and for batch and fatigue testing during product development

There are a variety of test procedures available. They are described below in order of importance.

1. Test torque: Defined as the minimum torque at which no relative motion occurs.
2. Breakaway torque: Simply defined as the torque measured when initial relative motion between the test nut and bolt occurs in bonded joints with or without pre-load. The direction of the applied force (tightening/loosening) is differentiated at the breakaway moment.
3. Inspection torque (in the tightening direction): This is defined as the torque at which further tightening of the bolt can be clearly recognized on a torque/time or torque/angle diagram. The inspection torque test is suitable for most joints with the exception of those joints that cannot be tightened or loosened under any circumstances, such as



setscrews. The proposed inspection torque test allows an indirect indication of the pre-load during testing (see Fig. 2.2.2).

### 3.4.1 Further Tightening to Inspect Joints

When performing the inspection torque test, an already tightened fastener is tightened further. This is done so that proper measuring of torque over either time or angle of rotation can be achieved. Once completed, this curve is recorded graphically.

Peak torque or breakaway torque, resulting from the effects of overcoming static friction is of no consequence in this instance. Only torque reached while rotation of no more than three degrees (hard joint) can be observed. Figures 3.4.1 and 3.4.1A further clarify this point.

Fig. 3.4.1

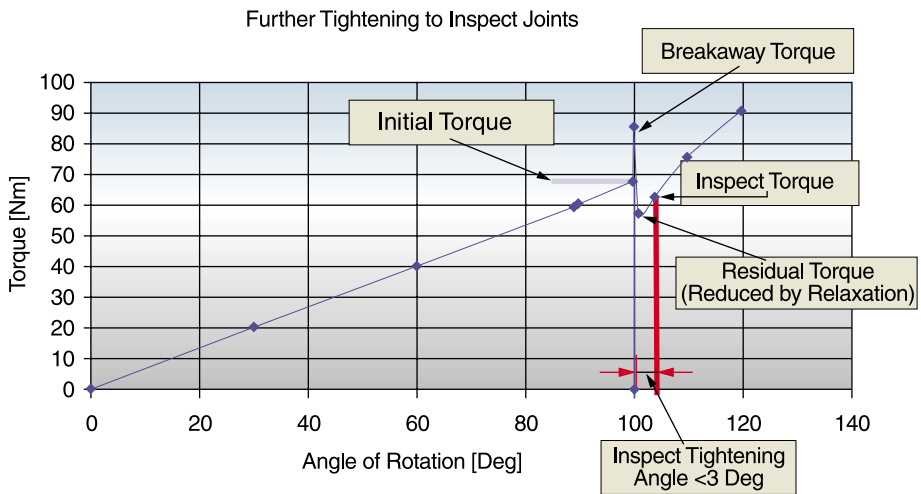
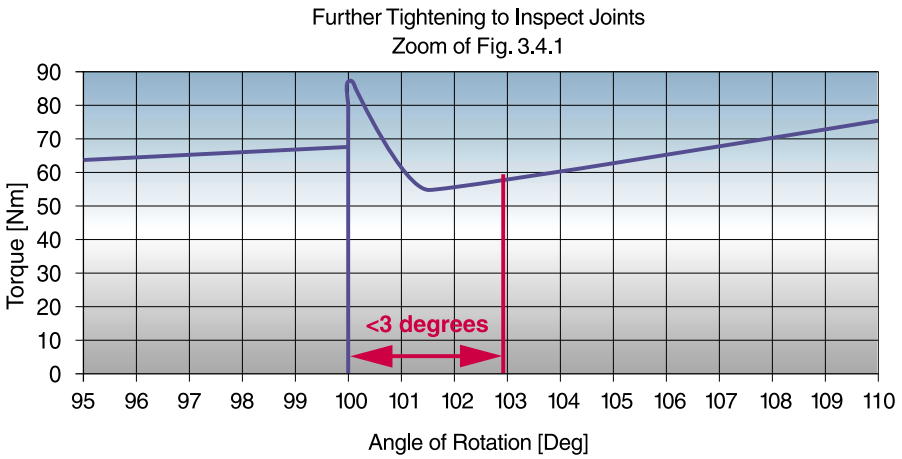


Fig. 3.4.1 A




### 3.4.2 Inspecting by Measuring Bolt Elongation

Applications requiring joints using beyond-yield tightening processes can be further tested by measuring bolt elongation. This is achieved by measuring the bolt length prior to joint assembly and following disassembly. Applying this method will determine the difference in length.

### 3.4.3 Inspecting by Means of an Inserted Torque Transducer

Inserting a torque transducer will assist the inspection process and allow determination of the maximum torque reached during the tightening process. If the tightening function is completed with a pulse tool, a dynamic peak torque will result. Furthermore, frequency behavior of the measurements and rundown will be processed while maintaining all preset boundary conditions. Lastly, it is imperative that the transducer is calibrated using extreme accuracy for every independent fastening process (see Section 5.2).

# **4. Functional Principle of Rotary Pulse Tools**



Rotary pulse tools are based on a principle similar to rotary impact tools. Pulse tools hydraulically transmit energy from the drive motor to the output spindle as compared to the rotary impact tools. These operate by using a striking mechanism.

The rotary pulse tool process is simplified in the following explanation: Oil flows into a designated rotating hydraulic chamber that is divided into sections by the blade. Once the blade reaches the intended position, it blocks the oil flow between the chamber halves. This effect increases hydraulic pressure, which is then transmitted to the output spindle assisted by its active surface.

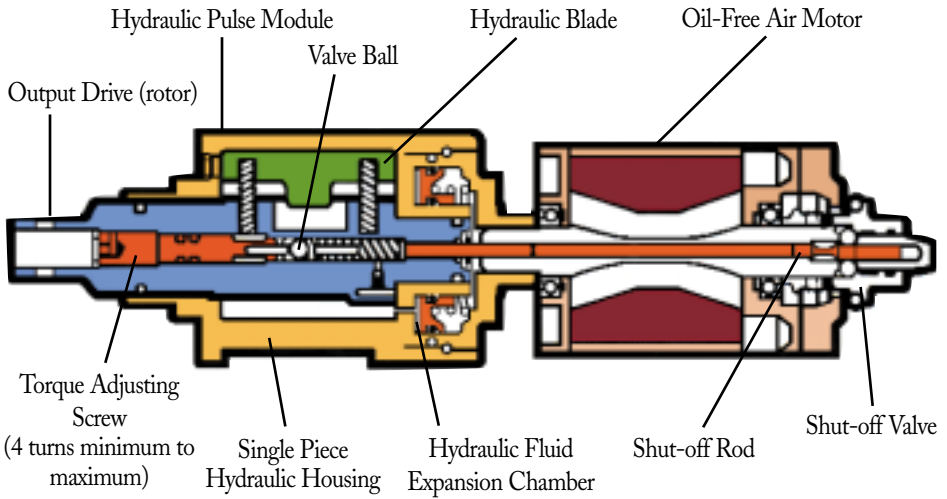
Applying the above into an assembly application environment can be best described as increasing the benefits to the operator by reducing noise levels and significantly reducing vibration.

Another contributing factor is a feature that allows torque adjustment with minimum effort. This is accomplished with CooperTools' external torque adjustment feature, simplifying the regulation of leaking oil flow through a bypass between the two chamber halves, therefore limiting the peak pressure and thus torque. This prevents increased torque particularly during longer impulses.

Fig. 4 is a cutaway of a CooperTools' pulse tool with an air motor.

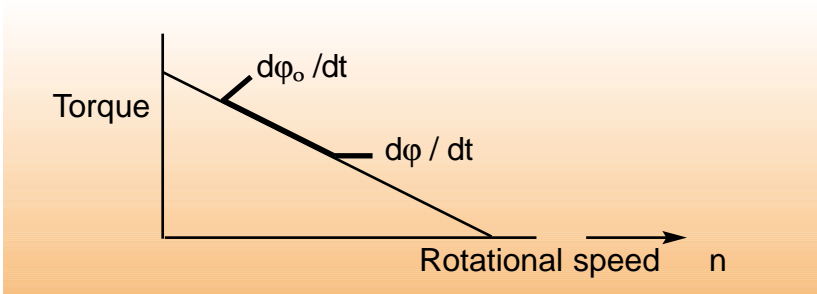


Fig. 4



#### 4.1 The Physical Relationships in Torque-Pulse Generation

Using an air motor drive as an example, a simplified diagram illustrating the physical relationships in torque-pulse generation is shown below. As the process begins, a fastener is run down until its head is seated. The air motor reaches a near stop following the first impulse. From an initial rotational speed  $n_0 \cong 0$ , the air motor accelerates the hydraulic unit to final speed  $n$  according to its characteristic or from an initial torque  $d\phi_0 / dt$  to a final torque  $d\phi / dt$ .



The momentum generated by the air motor is perceived as acceleration work by the hydraulic motor. The relationship is explained below:

Acceleration work = acceleration moment

$$\Theta * d \varphi^2 / dt^2 = Md (t)$$

$\Theta$  = moment of inertia

$d$  = differential

$\varphi$  = angle

$t$  = time

$Md$  = torque

To clarify this relationship, a simplified linearized example is used to calculate the imparted torque impulse.

The work transferred to the hydraulic unit, i.e., the imparted rotational energy is:

Mass moment of inertia of the hydraulic rotor

$$J = 3 * 10^{-4} \quad \text{kgm}^2$$

Final speed of the air motor (rps)

$$n = 60 \quad \text{s}^{-1}$$

Rotational energy of the hydraulic rotor

$$W_{rot} = J * (2 * \pi * n)^2 / 2 = 21.3 \text{ Joules}$$

The initial rotational energy generates hydraulic pressure in the hydraulic unit by using one or more blades to block the chamber. The gap created by preset manufacturing tolerances or a bypass valve will limit the maximum resulting pressure. This hydraulic pressure generates torque impulses  $Md$  via the mean surface and the mean effective radius of the blades on the output spindle.



Note that friction losses are not taken into consideration in the following equations.

The torque impulse is represented by the approximation:

$$Md = Wrot / \beta + \beta d \quad \text{angle in rads, Wrot in Joules}$$

Element  $\beta$  is the angle of rotation of the output spindle. Angle  $\beta d$  corresponds to the internal damping of the hydraulic unit.

Internal damping depends on the following factors:

- Gaps due to manufacturing tolerances
- Adjustment of the bypass valve
- Viscosity and temperature dependency of oil type used

Example:

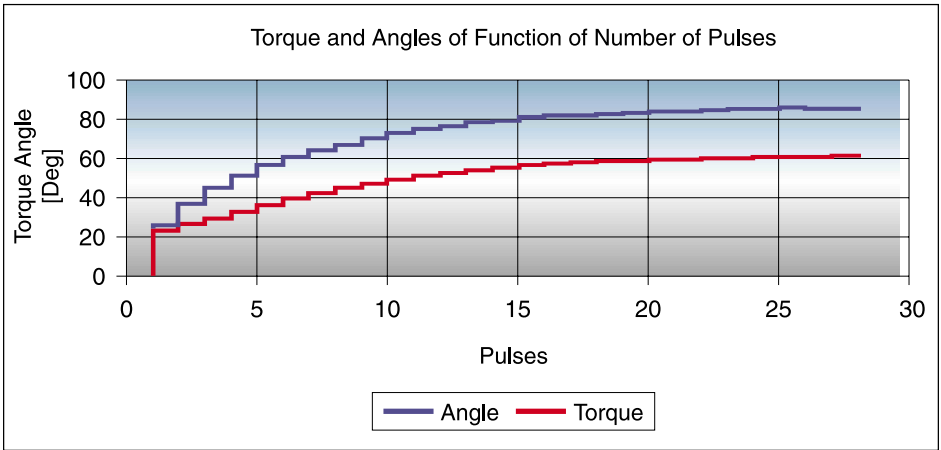
If the output spindle has an angle of rotation of approximately  $10^\circ$ , the internal damping  $5^\circ$  and  $Wrot$  is 21.3 Joules, a torque impulse of

$$Md \text{ impulse} = 21.3 / ((10^\circ + 5^\circ) * (\pi/180^\circ)) = 81.4 \text{ Nm}$$

is generated.

The related torque impulse is inversely proportional to the angle of rotation achieved on the output spindle. Internal damping and the pressure of the air supply will limit the torque impulse. However, the output spindle must not rotate. Torque impulse is constant for this adjustment setting. After a significant amount of pulses, the pulse tool graphically enters the horizontal slope of its characteristic. All subsequent impulses carry approximately the same magnitude. Fig. 4.1 shows the smoothed run of the angle of rotation and torque as a function of rundown pulses.

Fig. 4.1



Frictional conditions and bolt-joint relaxation behaviors can affect the tightening moment or the pre-load in the threaded fastener depending on the type of joint application. Refer to Section 2.2 for clarification.

## 4.2 Pulse Tools

The progressive evolution of hydraulic pulse tools has created tools of varying designs, which are lighter and produce more power with less vibration. Succeeding the original single-chamber pulse tools with one control blade, pulse tools with two and three chambers were developed and introduced to the market.

The original design principle is still maintained. Simply explained, the initial rotational speed of the pulse unit when it is completely filled with oil equals the speed of the air motor in idle mode. The rotating housing of the pulse unit is directly connected to the motor. The output spindle, rotating along with the oil, functions as the fastening output. The blade slides in and out of a slot in the output spindle and is pressed to the inside wall of the rotating housing.

The inside of the housing is eccentric to the output spindle. The pulse unit rotates at first (as described above) maintaining the same speed as

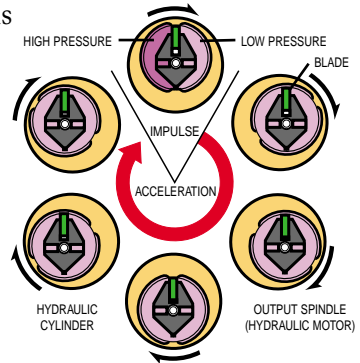


the air motor until the torque in the joint increases. At this point, the blade seals off the oil chamber and a torque impulse is generated. The blade is in its external position and oil flow is interrupted abruptly. When pressure drops after the torque impulse is released and the housing has rotated beyond the sealing position, the oil can again flow freely marking the beginning of a new working cycle. Placing the unit into reverse action, commands a torque impulse with opposite rotation, i.e., counterclockwise.

### 4.2.1 Cleco Single-chamber Pulse Tools

The illustration below elaborates on the function of a Cleco single-chamber pulse tool. In this type of tool, the hydraulic housing rotates clockwise. When placed in the upright position, the oil flow is interrupted and an impulse is generated on the output spindle.

Fig. 4.2.1



### 4.2.2 Cleco Dual-chamber Pulse Tools

Fig. 4.2.2 illustrates the functional principle of a Cleco dual-chamber pulse tool. Much like the single-chamber pulse tool, the housing also rotates in a clockwise direction. The difference however, is found in the design of four eccentric chambers positioned in a fashion that allows that the control blades to enter into a sealing position after each rotation, generating a torque impulse. The advantage is a more compact design offering approximately a 50% increase in power density.

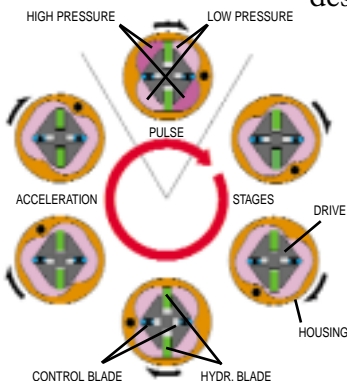


Fig. 4.2.2

### 4.2.3 Three-chamber Pulse Tools

The three-chamber pulse tool functions in the same manner as the two-chamber version. An added hydraulic quasi-parallel connection promotes increased power density.

### 4.2.4 Temperature Equalization in Cleco Pulse Tools

Cleco pulse tools feature a patented pressure-expansion chamber, designed to receive hot and expanding oil. This innovation extends the service life of the tool, prolonging performance. The illustration below, Fig. 4.2.4, reveals the cross-section of a pulse tool with an oil expansion chamber.

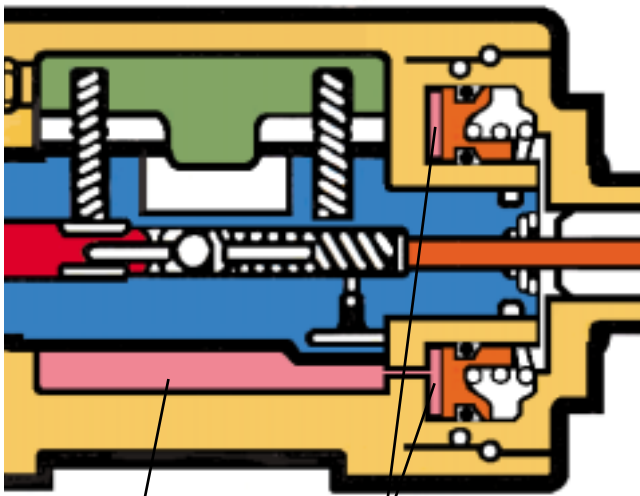
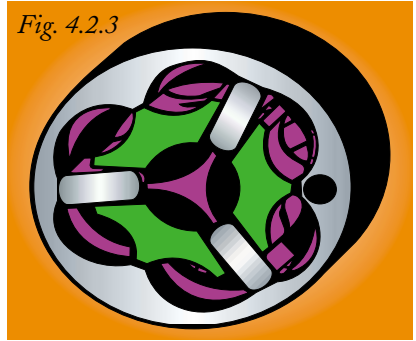


Fig. 4.2.4

Hydraulic Fluid

Expansion Chamber

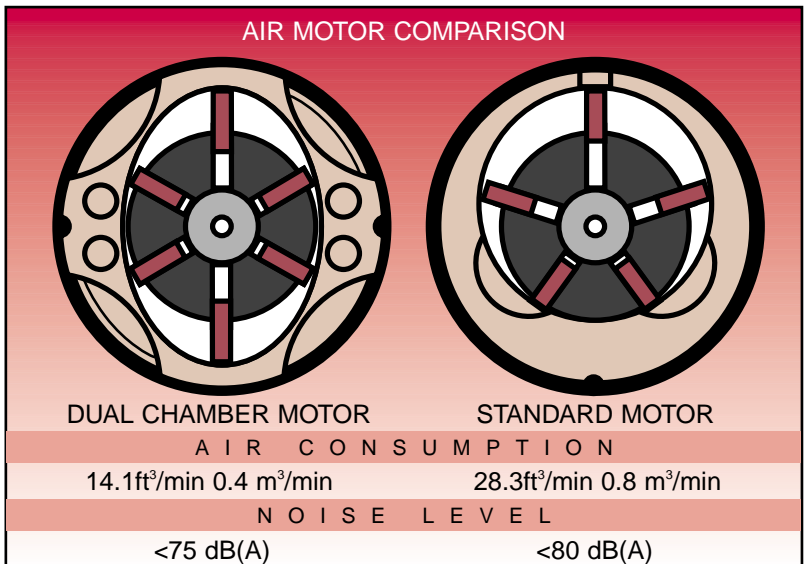
## 4.3 Drive Systems



Air pressure motors are most commonly used in rotary pulse tool drive systems due to their good power-to-weight ratio. Another advantage of the air motor is the ability to accommodate the demands of a hydraulic pulse unit, which requires a motor to come to a near stop at each impulse. Another form of drive system like the electric motor conversely requires special reduction measures as a result of their high-speed dynamics. This option would prove to be inappropriate for the task.

Increased performance is always a welcomed and much needed improvement. Cleco has developed a dual-chamber motor that provides significant advantages in the areas of most importance. Improved features include; reduced air consumption; lighter tools; increased power-to-weight ratios; lower noise levels. To further explain this concept, please refer to Fig. 4.3, which illustrates a cutaway of a dual-chamber motor compared to the common single-chamber motor. Both have the same outside diameter. With this design, air consumption was significantly reduced by 50% and noise levels significantly reduced by 5 dB(A).

Fig. 4.3



## 4.4 Shut-off Principles and Torque Adjustment Means

Torque must be adjustable and the pulse tool stoppable, if necessary, after a certain moment is reached in order to achieve a sufficient tightening accuracy for threaded joints. Fig. 4.4 shows a typical rundown with pulse and pre-load curves as functions of time.

The impulse intervals, also called the pulse frequency, are almost constant. The pulse amplitude and the pre-load increase step by step from each pulse to the next. Due to the large difference in amplitude at the start of the rundown, a large amount of torque and pre-load scatter will result if shut-off occurs this early. Therefore, a pulse tool should only be shut off in the horizontal slope of the characteristic.

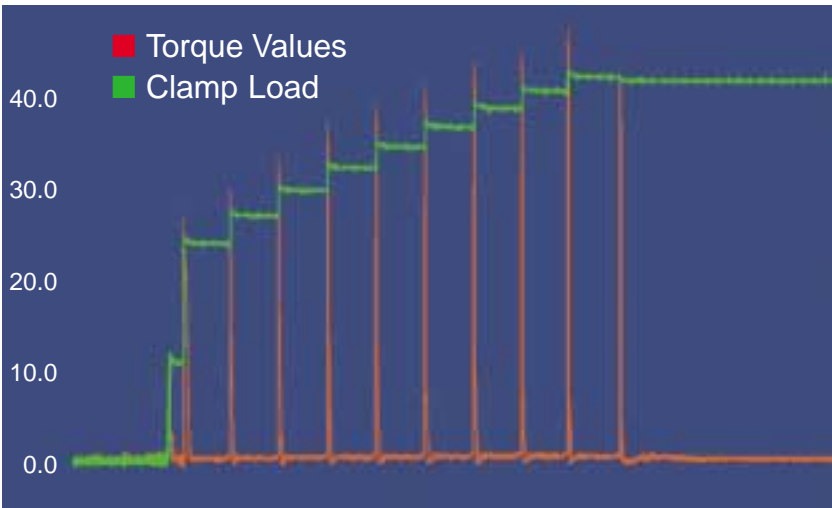


Fig. 4.4

Typical joint run down signature of a pulse tool.

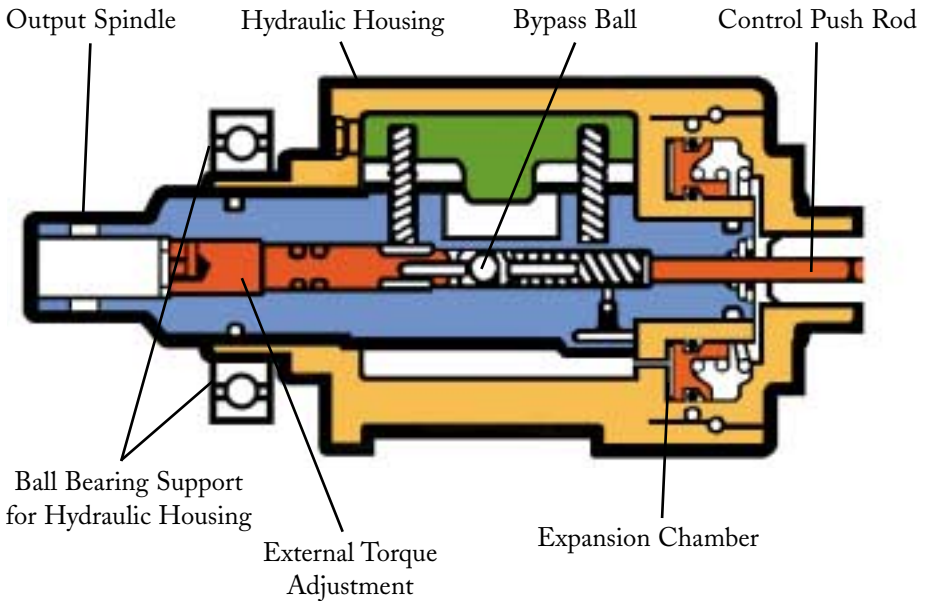
### 4.4.1 Torque Adjustment and Torque Shut-off through Pressure in the Pulse Tool

The pressure build-up in a pulse tool allows for torque adjustments to be made through a bypass located in the tool (Refer to the diagram in Section 4.2 for further clarification). Cleco has designed their pulse tools to make this function even easier. The adjustment screw positioned



on the output spindle allows the operator to modify torque externally, quickly and easily without disassembly. Fig. 4.4.1.1 shows the patented principle of this torque adjustment feature.

Fig. 4.4.1.1



For further clarification of the association between turns of the adjustment screw and torque see Fig. 4.4.1.2 below. This example uses a Cleco pulse tool - model no. 35PTH.

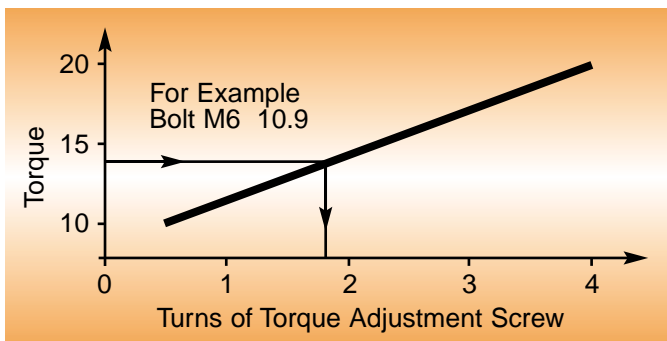
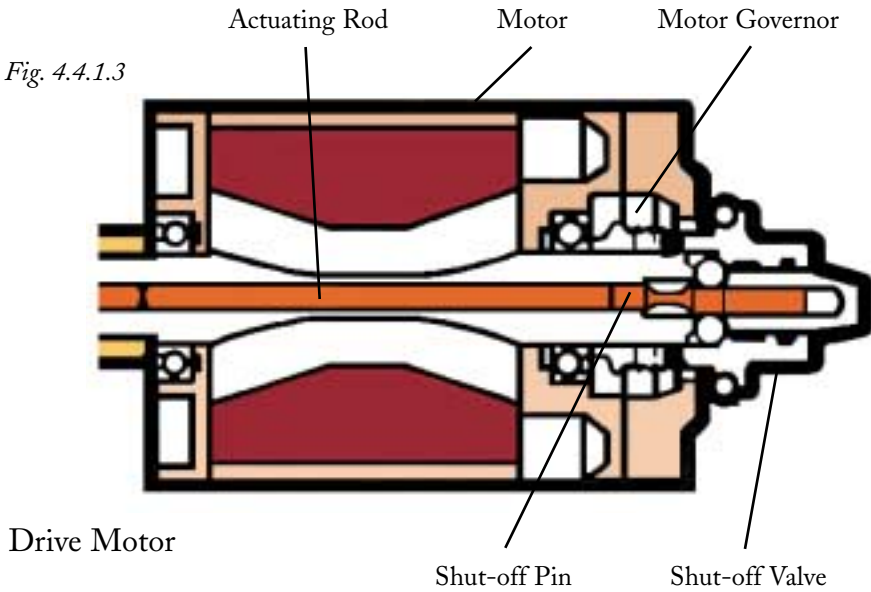


Fig. 4.4.1.2

In simplified terms, shut-off torque occurs when the pressure in the pulse unit is detected and specified torque is reached. Cleco pulse tools offer a patented shut-off device in conjunction with a throttle washer to limit the free speed.

Fig. 4.4.1.3 shows the cross section of an air motor with a governor and shut-off device.



#### 4.4.2 Torque Adjustment by Throttling the Exhaust and Shut-off by the Operator (No Automated Shut-off)

Adjusting torque can also be achieved through exhaust throttling. Cleco pulse tools employ an exhaust throttle mechanism specifically designed to be user friendly. By applying this technique, exhausted air is reduced, allowing the pulse tool to consistently produce a preset torque. This method consistently delivers high accuracy levels on hard joints. A very important factor considering that 85% of all threaded joints are hard joints.

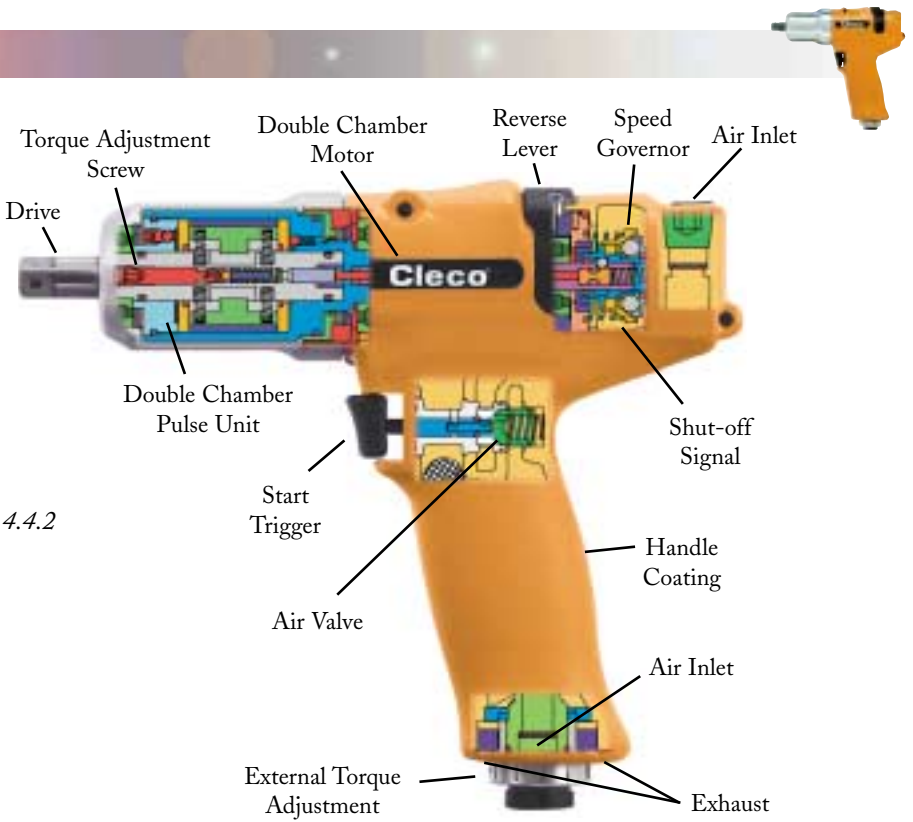


Fig. 4.4.2

#### 4.4.3 Electronically Torque Controlled Pulse Tools

The CooperTools electronic controller and pulse tool with an integrated or attached transducer has the capability to perform torque adjustment and control through the air supply. Fig. 4.4.3.1 shows the configuration of this type of system. This system offers the flexibility of selecting and adjusting the pressure and/or pressure change of compressed air supply depending on joint requirements. When the preset torque is reached, a valve cuts off the air supply. Numerous joint parameters can be adjusted, monitored, documented and statistically evaluated.

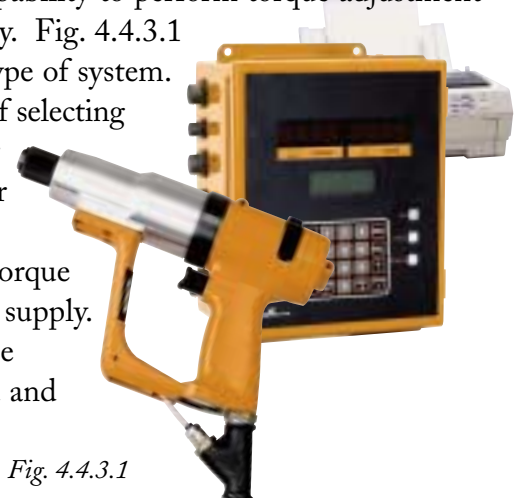
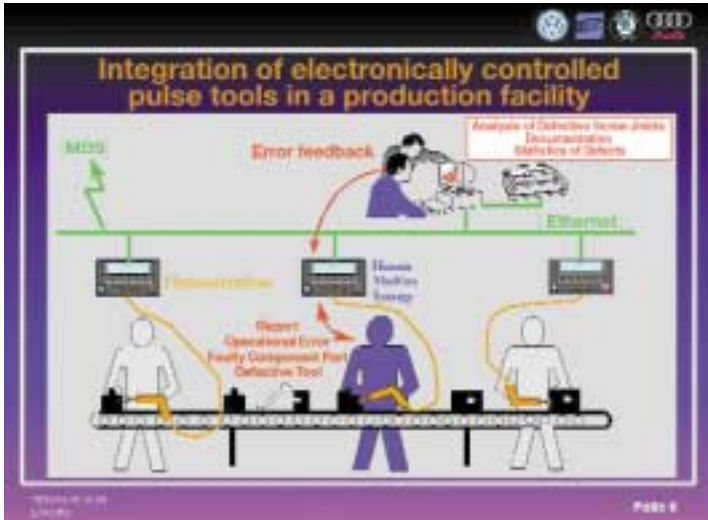


Fig. 4.4.3.1

Fig. 4.4.3.2 illustrates the integration of electronically controlled pulse tools in a production facility.

Fig. 4.4.3.2



#### 4.4.4 Electronically Controlled and Monitored Pulse Tools in Regard to Torque and Time

Achieving continuous accuracy is imperative in an assembly operation. Electronically controlled pulse tools can prove to be invaluable in this instance. For example, recording the accuracy of tightening moments with low scatter can be obtained by monitoring a pulse tool for torque and time in beyond-yield tightening processes. Torque can be adapted depending on joint requirements using the air supply. Additionally, when the specified torque range is reached, combined with a sufficient number of pulses within the preset time allotted, allows the pulse tool to shut off therefore delivering an accurate and accepted tightening process. This accuracy is further confirmed by an “OK” signal (light) on the controller.

#### 4.4.5 Inertial Shut-off

Inertial shut-off measures torque indirectly through the inertia of a given mass in the pulse tool. Once the inertial force of the mass exceeds a preset spring force, a valve cuts off the air supply.

# 5. Behavior of Pulse Tools

The background is a dark, gradient field with a prominent lens flare in the top-left corner. Several overlapping, semi-transparent circles in shades of orange, yellow, and blue are scattered across the lower half of the image, creating a bokeh effect.

Various torque-measuring methods and calibrations can be used to describe the behavior of rotary pulse tools with different kinds of threaded joints. See Section 5.1 and 5.2. Pulse tools are characterized by the impulse-shaped torque output signatures, these impulses measure approximately one millisecond. Because of this, increased demands are placed on the type of measuring equipment used mostly focusing on measuring frequency, frequency behavior and filter setting.

Some of the influential factors influencing measuring results are qualified as follows: all relevant rotating masses, elastic torsion, and frictional effects on the output spindle. These can be affected due to the result of short impulse duration. Similarly, the effected angle of rotation of the output spindle during impulse also falls under this category. To obtain low scatter of torque measurement results, close tolerance dependencies demand dynamic calibration of the pulse tool for each specific joint.

Quantifiable determination of what pulse shape or pulse height increase is necessary to generate pre-load and rotation has not been accurately determined. Conclusive research is still underway.

### 5.1 Threaded Joints According to ISO 5393

Two types of threaded joints are specified by ISO 5393 standards. In particular, hard and soft joints are used to test tightening tools. These tests are used as a benchmark to define the statistical evaluation of the test sequence.

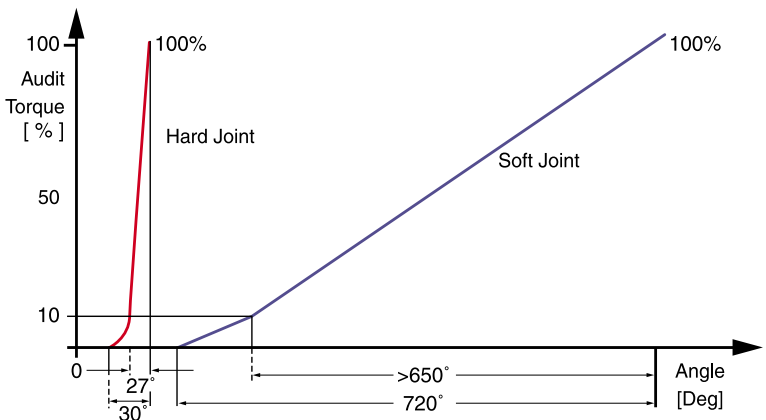


Fig. 5.1.1



Hard and soft joints define the spectrum of possible joints, and are often used to describe the specific behavior of rotary pulse tools.

A hard joint is best described as a joint that easily rotates before all parts involved are properly seated, resulting in a quick torque rise that happens between snug and maximum torque in less than 30°. Close tolerance and the probability of overshooting are common.

By comparison, a soft joint experiences significant rotation under load prior to reaching its target torque. The downside of using a soft joint is that it will require the tool to work harder than if applied to a hard joint. The benefit is that tool inertia is minimized if not almost eliminated at the point when the tool reaches the target. This results in closer torque tolerances and almost non-existent overshoot.

Fig. 5.1.2

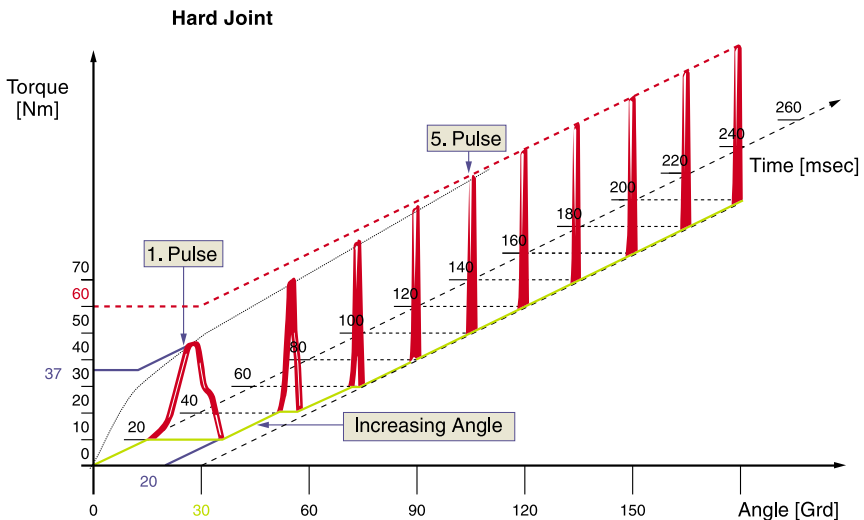


Fig. 5.1.2 shows the typical behavior of the more critical hard joint. In the example shown, the pulse tool is adjusted through compressed air regulation to 60 Nm maximum torque output at a frictional pulse frequency of 50 Hz (20 msec). The tightening process requires 60 Nm of torque at an angle of 30 degrees.

The diagram in Fig. 5.1.2 illustrates a different scenario. The bolt shown has been run down to the point where the head is seated. After 20 msec have elapsed, the pulse tool with an angle of 20 degrees and a peak torque of 37 Nm generates the first pulse. In the next 20 millisecond (the second pulse) peak torque of 50 Nm, is generated. At this point, the bolt is tightened another 5 degrees. This process is continuously repeated until the maximum torque output is reached. This equates to 60 Nm at the 100 millisecond mark with a 30 degree tightening angle. The pulse tool can be shut off once this stage is reached.

Premature shut-off is best described when a controller with a pre-selected torque shuts off the tool. This is applicable, both if the tool shuts off on its own and if it is intentionally shut off.

A considerable amount of deviation can be expected in this situation, created by the large variances in pulse amplitudes at the beginning of the tightening process.

Joint precision can be achieved only if the pulse tool is adjusted to its specific torque requirement, allowing the tool to produce the necessary number of pulses. This process applies particularly to hard joints.

The process of achieving precision on a soft joint is a bit different. Here, more pulses are required due to the distinguishing factors of the flat torque-angle characteristic. Because the differences in torque amplitudes are less at identical torque values, a lesser amount of torque scatter is detected although an adequate amount of pulses are still necessary.

## **5.2 Torque Measuring Methods and Calibration**

Existing measuring methods have proven unsuccessful when used to conduct torque inspections. The difficulty is due to the pulse-shaped torque transmission that occurs between rotary pulse tools and fasteners.



Because the accuracy of measuring methods is necessary, a global standards committee is in the process of developing a standardized procedure that will simplify the torque verification process.

Within the following segments of this section is further descriptive of proven practice-oriented torque audit methods for rotary pulse tools. Methods for inspecting test equipment are also covered.

### **5.2.1 Test Equipment for Pulse Tool Audits**

ISO 5393 specifies requirements for threaded joint test equipment. These requirements are consistently accurate throughout the application range.

If a rotary tool demonstrates low rotational speed ( $n < 50$  1/min) a joint characteristic test, including torque as a function of angle of rotation should be conducted. If applicable, testing for torque as a function of pre-load may also be relevant.

Defining the test equipment is an important step. CooperTools' recommendation of accurate testing equipment is as follows:

- Torque/angle monitoring unit
- Add on transducer with torque and angle detector
- Plotter

For confirmation and consistency of proper inspection results, CooperTools recommends that inspection be repeated at least three times at the beginning and end of the test.

### **5.2.2 Reference Testing of Pulse Tools on "Fastened Joints"**

Determining the calibration data of the measuring equipment can be achieved by testing the pulse tool on a threaded joint. An absolute angle of approximately 120 degrees must be maintained, while adapting fastener dimensions to the fastening torque. The goal is achieved only when the torque of the measuring equipment and the fastened joint are alike.

The formula below outlines the steps to follow in determining the calibration data.

**Procedure to follow:**

1. Enter transducer nominal value in the measuring electronics
2. Tighten with the pulse tool and transducer (noting indicated values)
3. Detect the audit torque value of the joint, e.g., with a torque wrench
4. This results in the following dynamic calibration value.

Calculation according to the following formula:

Audit torque (3)

\_\_\_\_\_ x nominal value, old (1) = dynamic calibration value, new (4)

Indicated torque (2)

### **5.2.3 Calibration and Testing of Rotary Pulse Tools on a Joint Simulator**

Section 4.1 simplifies and further explains the association between the oil pressure generated within the pulse unit of a pulse tool and the design of the Cleco shut-off mechanism.

A direct proportional relationship exists between the oil pressure in the pulse unit and the produced torque, given that the output spindle does not rotate. In this instance, damping of the various connecting links is of no consequence, allowing the determination of calibration data in test equipment.

In a test environment using test equipment on a fastened joint, let's assume that an indicated value of 30 Nm is reached while conducting dynamic testing. These results are further confirmed by taking a reading of audit torque. If the tests were conducted flawlessly, the outcome should report identical indicated values obtained without the need for tool adjustment.

If this value deviates, the following measures must be taken:



Check the adapters, attachments, and extensions used in the connections between the tool and test equipment. Test the mass moment of inertia of the test devices (if the mass moment of inertia is too great, shut-off can be effected too early).

Check the influence of a hand-held or clamped tool. This test can usually be accomplished by comparing measurements between the statistical tightening values of a joint to the data recorded by the test equipment.

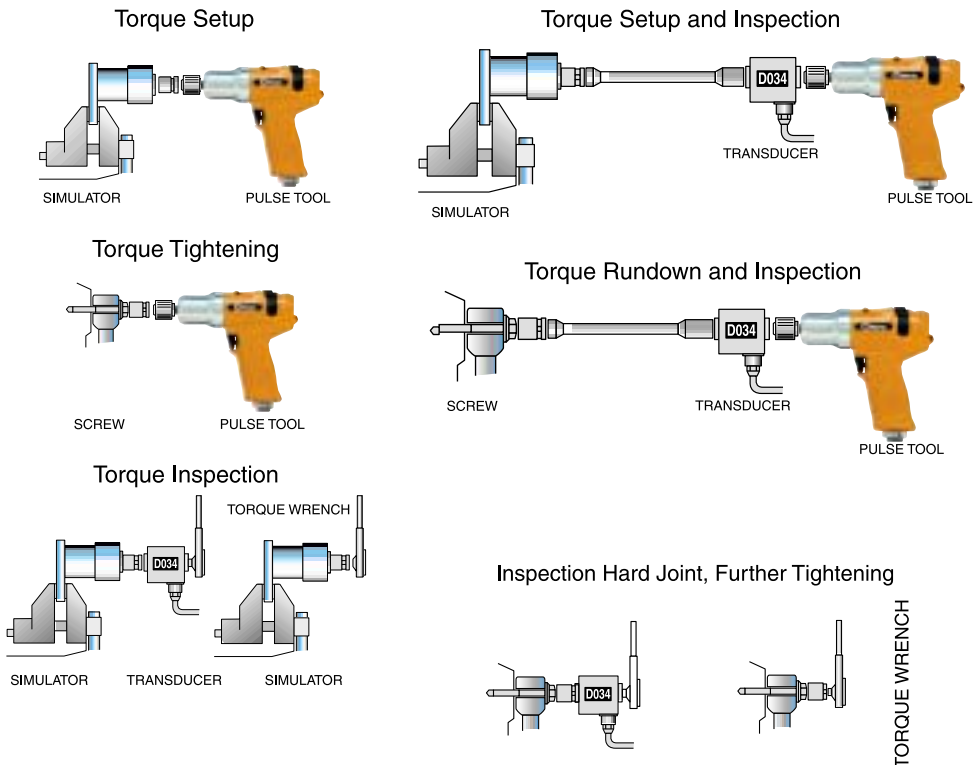
Fig. 5.2.3.1 to Fig. 5.2.3.3 shows the measuring methods.

Fig. 5.2.3.1 shows the setup, audit, and rundown.

Fig. 5.2.3.2 shows the setup, audit, and rundown with an attached transducer.

Fig. 5.2.3.3 shows the audit of a soft and a hard joint.

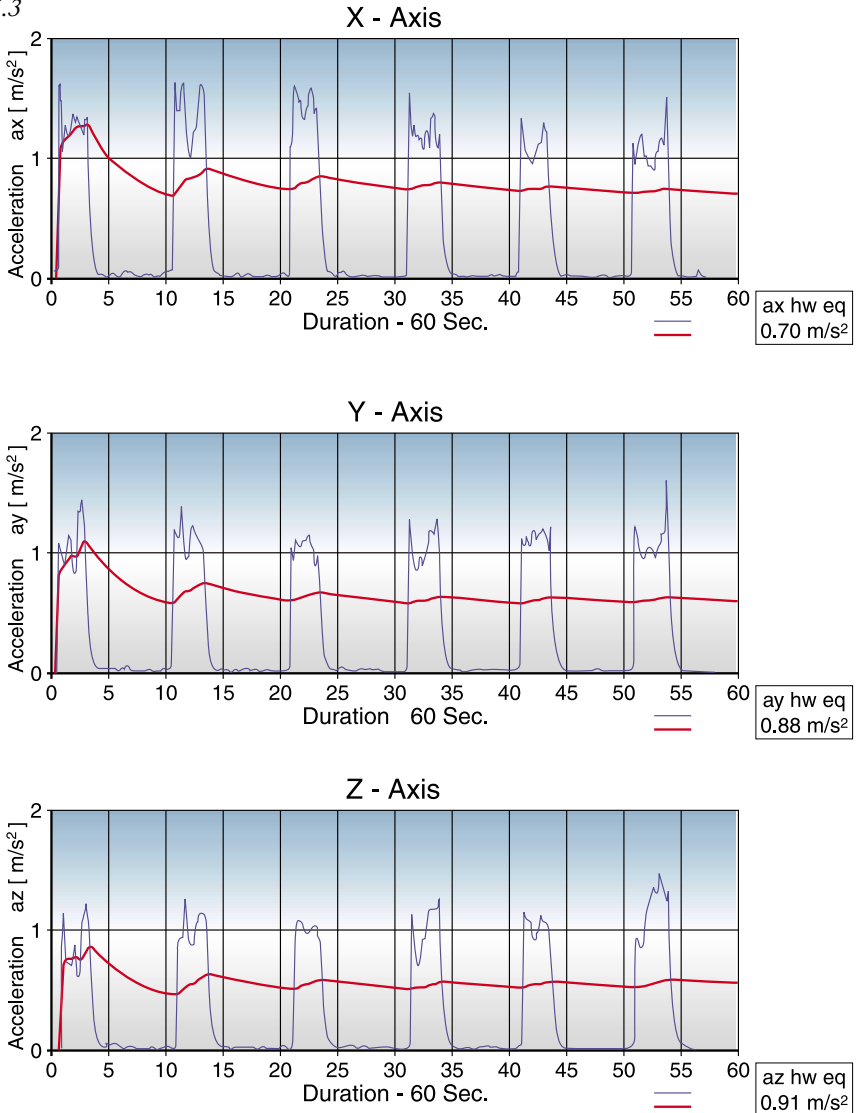
Fig. 5.2.3.1



## 5.3 Vibration Levels

Fig. 5.3 shows a typical vibration level curve measured on the pistol grip handle of a rotary pulse tool in three axes (x, y, z). The values illustrated are significantly under the permissible value limits specified by ISO 5349 ( $2.5 \text{ m/sec}^2$ ).

Fig. 5.3



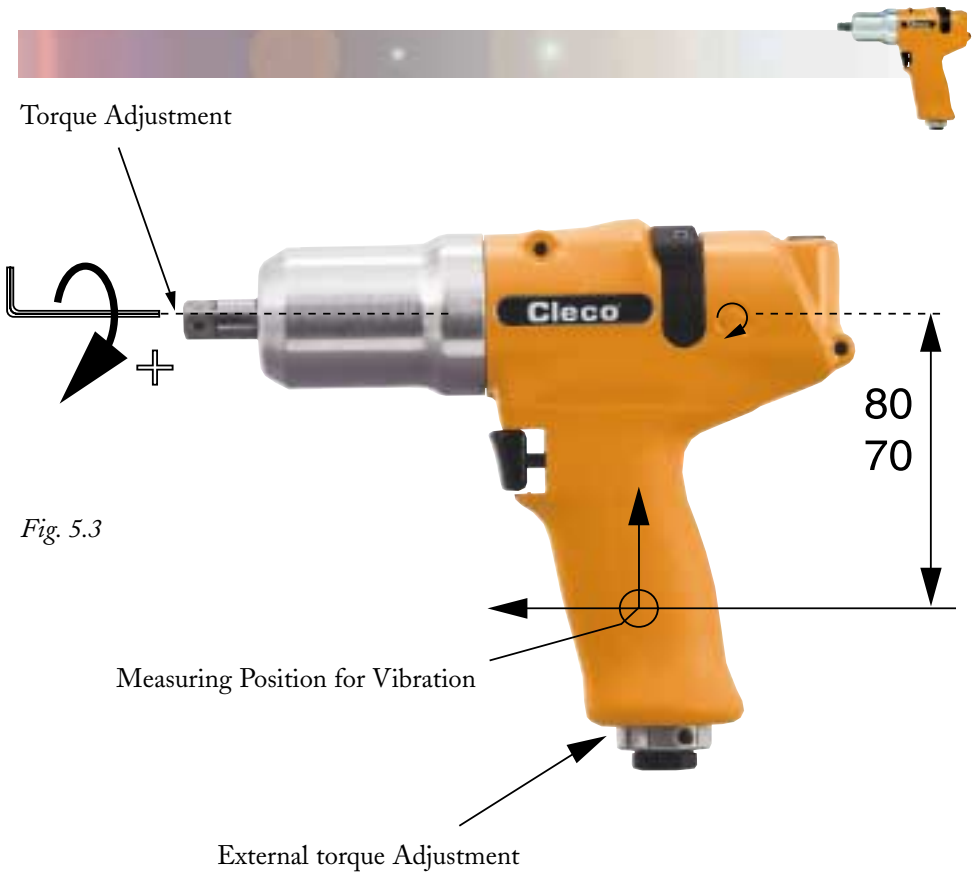


Fig. 5.3

## 5.4 Noise Levels

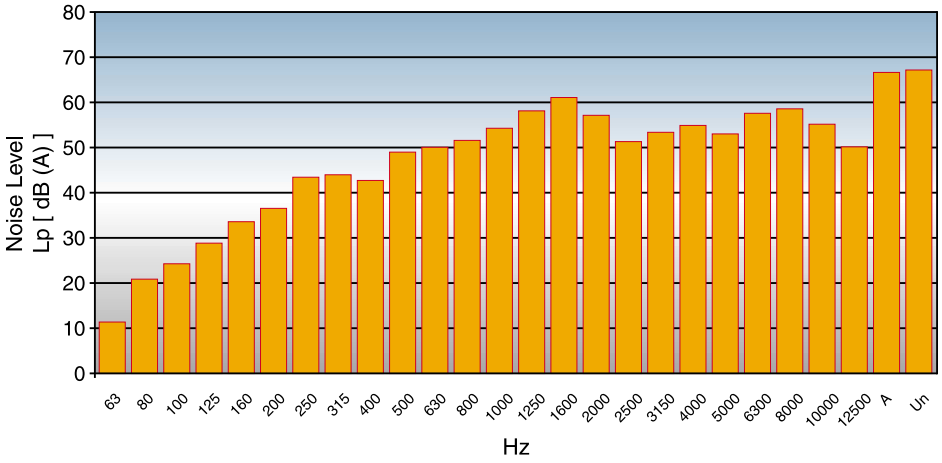
Noise levels in repetitive environments can be an extremely important factor when selecting a pulse tool. Over the last few years, manufacturers have been placing particular emphasis on reducing noise levels. CooperTools has taken this into account and now offers products with significantly reduced noise levels achieved by optimizing the design of the air motor located in the pulse unit. Furthermore, this reduction reports noise levels as low as 72 dB(A), meeting and/or exceeding the standards outlined by ISO 3744.

See Fig. 5.4, which illustrates the noise level of the newly designed CooperTools pulse tools.

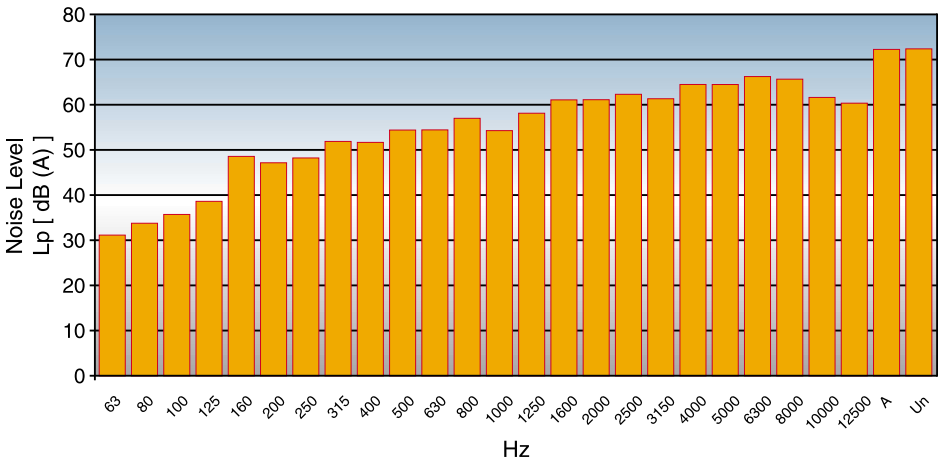
Fig. 5.4

# Frequency Analysis

## Free Speed



## Pulsing



## 5.5 Test Equipment for Tool Capability Auditing



A mobile simulator represented in Fig. 5.5.1 can be used to audit tightening tools. These systems are most accurate in testing joint-specific tightening with different adjustable torque and brake angles. Amongst the various types of tests that can be conducted with these systems is the Capability Audit. It is composed of a minimum of 25 rundowns within a small window and combines data recording and evaluation as part of the test.

As mentioned previously in this booklet, the DKD (Deutscher Kalibrier Dienst) a subsidiary of Calibration Laboratories has joined forces with ISO-TC. These entities have formed committees that will be responsible for conducting research and establishing guidelines across industry, aiding in the process of specifying auditing methods for pulse tools that will be applicable on a global level.

Fig. 5.5.1 shows the test equipment from BLM, Milano, Italy.



*Fig. 5.5.1*

# **6. Examples of Industrial Applications using Pulse Tools**



Fig. 6.1 illustrates a Cleco model #105PTH pulse tool in a motor assembly environment at MAN's.



*Fig. 6.1*

Fig. 6.2 illustrates a Cleco model #160PTH pulse tool being used to assemble a classic MTU engine. photo: Norbert Barlmeyer



*Fig. 6.2*

# 7. Future Developments

The background features a dark, gradient field with several overlapping, semi-transparent circles in shades of orange, yellow, and blue. A prominent lens flare is visible in the top-left corner, and a small, bright green star-like point is located near the center of the page.



CooperTools is committed to the development of product ingenuity that will provide our customers with the solutions they require and expect. To further this goal, future developments will be focused on continuing to enhance our product benefits to fulfill the ultimate in smaller, lighter and faster tools that can surpass present achievements in performance, flexibility and utmost quality.

In this quest, particular attention is being given to the improvement of power-to-weight ratios, new materials, improved drive technology and improved electronic functions. Other developments may also include the areas of simplifying calibration procedures and pre-load replication capacity.


Our extensive research indicates that improvements in both efficiencies and simplification of use is the catalyst that will increase pulse tool usage in the industry and therefore increase overall pulse tool success in today's market.

# 8. Bibliography





- |                         |   |                           |
|-------------------------|---|---------------------------|
| 1. Berger               | Reibung und Schmierung  | Catalog Fa. Berger        |
| 2. Bossard              | Handbuch der Verschraubungstechnik  | Expert Verlag 1982        |
| 3. DGD                  | Impulsschraubersteuerung  | DGD 11/1995               |
| 4. DIN 267              | Mechanische Verbindungselemente, Qualitätsanforderungen                                     | DIN                       |
| 5. DIN Pocket book      | Mechanische Verbindungselemente 3   | Beuth Verlag 1990         |
| 6. Großberndt, H        | Die automatische Montage mit Schrauben  | Expert Verlag 1980        |
| 7. ICS Manual           | Automatische Schraubenmontage   | Mönning Verlag 1993       |
| 8. ISO                  | Rotary tools for threaded fasteners   | ISO / TC 119 1991         |
| 9. ISO 5393             | Schraubfälle  | ISO / TC 118 1991         |
| 10. ISO 898             | Mechanische Eigenschaften von Verbindungselementen  | ISO 1988                  |
| 11. Kettner, K          | Compressed air screw bolt tightener, especially an impulse or a torque screw bolt tightener | US Patent 5 439 063       |
| 12. Kettner, K et all   | Hydroimpulse screwing device  | US Patent 5 217 079       |
| 13. Kettner, K et all   | Hydro impulse screw tool  | US Patent 5 172 772       |
| 14. Pfaff, H Thomala, W | RIBE Blauheft   | Bergner GmbH              |
| 15. Polzer, B           | Electronische Messung und Steuerung von Drehmomenten in Montagemaschinen                    | VDI Bericht Nr. 323, 1978 |
| 16. VDI 2230            | Systematische Berechnung hochbeanspruchter Schraubverbindungen                              | VDI Verlag                |
| 17. Volkswagen AG       | Hochbeanspruchte Schraubverbindungen  | VW AG Company document    |



18. Volkswagen AG	Fugetechnik	VW AG Company document
19. Werthe, B	Schraubzeitvergleich von Impuls- und Elektroschrauber	VW AG
20. Werthe, B	Wertschöpfung und Einsparpotential in der Schraubenmontage	VW AG
21. Werthe, B	Überlastische Schraubenmontage	VW AG
22. Werthe, B	Wirkungsgrad einer Schraubverbindung	VW AG

*CooperTools acknowledges the dedication of Alan Edwards – Manager, Graphics Communications and MJD International, who made this publication a reality.*



**AIRETOOL®**

**APEX® • BUCKEYE®**

**CAMPBELL® • CLECO®**

**COOPER AUTOMATION • CRESCENT®**

**DGD® • DOLER® • DOTCO® • EREM®**

**GARDNER-DENVER® • GARDOTRANS**

**GETA • KAHNETICS® • LUFKIN®**

**MASTER POWER® • METRONIX**

**NICHOLSON® • PLUMB® • H.K. PORTER®**

**QUACKENBUSH • RECOULES • ROTOR™**

**UTICA® • WELLER® • WIRE-WRAP®**

**WISS® • XCELITE®**

**COOPER Tools**

P.O. Box 1410  
Lexington, SC 29071-1410, USA  
Phone: 803-359-1200  
Fax: 803-808-6735  
[www.cooperindustries.com](http://www.cooperindustries.com)

Cooper Power Tools GmbH & Co.  
Postfach 30  
D-73461 Westhausen, Germany  
Phone: (49)7363-810  
Fax: (49)7363-81222